

KENWOOD

KDC-PSW9527 KDC-W9027 KDC-W8027

CD-RECEIVER

INSTRUCTION MANUAL

KENWOOD CORPORATION



© B64-2746-00/00 (EV)



Contents

Safety precautions	4	Tuner features	33
Notes	6	Tuning	
About CDs	7	Direct Access Tuning	
Notes on playing MP3/WMA	8	Station Preset Memory	
Notes on Multi-function Key System	10	Auto Memory Entry	
Notes on Sound Management System	11	Preset Tuning	
General features	12	SNPP (Station Name Preset Play)	
Power		RDS features	35
Hiding the Control Panel		Traffic Information	
Selecting the Source		Radio Text Scroll	
Volume		PTY (Program Type)	
Attenuator		Program Type preset	
Rotary Volume knob operation mode select		Changing Language for PTY Function	
Display Mode Switching		CD/MP3/WMA/External disc control features	38
Text Display Switching		Playing CD & MP3/WMA	
Side Graphic Display Switching		Playing External Disc	
Graphic part/ Spectrum Analyzer Display Switching		Fast Forwarding and Reversing	
Wallpaper selecting		Track/File Search	
Text Display Switching		Disc Search/Folder Search	
External Display Switching		Direct Track/File Search	
Auxiliary Input Display Setting		Direct Disc Search	
Panel Position Setting		Track/File/Disc/Folder Repeat	
Theft Deterrent Panel		Scan Play	
TEL Mute		Random Play	
System Q (KDC-W8027)		Magazine Random Play	
System Q (KDC-PSW9527/KDC-W9027)		Folder Select	
Audio Control (KDC-W8027)		Disc Naming (DNPS)	
Speaker Setting (KDC-W8027)		Text/Title Scroll	
Dual Zone System		DNPP (Disc Name Preset Play)	
Subwoofer Output		GSM Hands Free Unit control features	43
Sound management features (KDC-PSW9527/KDC-W9027)	26	Receiving a call	
Audio control		Phone Book Search	
Audio Setup (Easy mode)		Direct Dial	
Audio Setup (PRO mode)		SMS (Short Message Service) Mode	
Audio Setup Memory (PRO mode)		Phone Book/ Message (SMS) data synchronize	
Audio Setup memory Recall			

Menu system **46**

Menu System
Security Code
Touch Sensor Tone
Manual Clock Adjustment
Phone voice speaker setting
Microphone sensitivity adjust
Auto Response time Adjust
Date Adjustment
Date Mode
Synchronize Clock
DSI (Disabled System Indicator)
Selectable Illumination
Triangle indicator setting
Font Type Select
Dimmer
OFF Wait Time Setting
Eject angle setting
Panel action setting
System Q Setting(KDC-W8027)
Audio Setup (KDC-PSW9527/KDC-W9027)
Built-in Amp Mute Setting
B.M.S. (Bass Management System)
B.M.S. Frequency Offset
News Bulletin with Timeout Setting
Local Seek
Tuning Mode
Auto Memory Entry
AF (Alternative Frequency)
Restricting RDS Region (Region Restrict
Function)
Auto TP Seek
Monaural Reception
Text Scroll
Power OFF Timer
Built-in Auxiliary input Setting
CD Read Setting
Picture downloading (KDC-PSW9527)
AMP Control
Rotary volume operation select

Basic Operations of remote **55**

Loading and Replacing the battery
Basic operations
In Tuner source
In Disc source
GSM Hands Free Unit operations

**Accessories/
Installation Procedure** **57**

Connecting Wires to Terminals **58**

Installation **60**

Removing the Unit **61**

Troubleshooting Guide **62**

Specifications **66**

Safety precautions

▲WARNING

To prevent injury or fire, take the following precautions:

- Insert the unit all the way in until it is fully locked in place. Otherwise it may fall out of place when jolted.
- When extending the ignition, battery, or ground wires, make sure to use automotive-grade wires or other wires with a 0.75mm² (AWG18) or more to prevent wire deterioration and damage to the wire coating.
- To prevent a short circuit, never put or leave any metallic objects (such as coins or metal tools) inside the unit.
- If the unit starts to emit smoke or strange smells, turn off the power immediately and consult your Kenwood dealer.
- Make sure not to get your fingers caught between the faceplate and the unit.
- Be careful not to drop the unit or subject it to strong shock.
The unit may break or crack because it contains glass parts:

▲CAUTION

To prevent damage to the machine, take the following precautions:

- Make sure to ground the unit to a negative 12V DC power supply.
- Do not open the top or bottom covers of the unit.
- Do not install the unit in a spot exposed to direct sunlight or excessive heat or humidity. Also avoid places with too much dust or the possibility of water splashing.
- Do not set the removed faceplate or the faceplate case in areas exposed to direct sunlight, excessive heat or humidity. Also avoid places with too much dust or the possibility of water splashing.
- To prevent deterioration, do not touch the terminals of the unit or faceplate with your fingers.
- Do not subject the faceplate to excessive shock, as it is a piece of precision equipment.
- When replacing a fuse, only use a new one with the prescribed rating. Using a fuse with the wrong rating may cause your unit to malfunction.
- To prevent a short circuit when replacing a fuse, first disconnect the wiring harness.
- Do not place any object between the faceplate and the unit.
- Do not apply excessive force to the moving faceplate. Doing so will cause damage or malfunction.
- Do not apply excessive force to the open faceplate or place objects on it. Doing so will cause damage or breakdown.
- Do not use your own screws. Use only the screws provided. If you use the wrong screws, you could damage the unit.

About CD players/disc changers connected to this unit

KENWOOD disc changers/ CD players released in 1998 or later can be connected to this unit.

Refer to the catalog or consult your Kenwood dealer for connectable models of disc changers/ CD players.

Note that any KENWOOD disc changers/ CD players released in 1997 or earlier and disc changers made by other makers cannot be connected to this unit. Unsupported connection may result in damage. Setting the "O-N" Switch to the "N" position for the applicable KENWOOD disc changers/ CD players. The functions that can be used and the information that can be displayed will differ depending on the models being connected.



- You can damage both your unit and the CD changer if you connect them incorrectly.

LX-bus connection

The LX AMP and the sensor unit cannot be connected simultaneously.

You must connect any of them at a time.

(The power supply does not turn ON if you have connected both of them.)

Do Not Load 8 cm (3 in.) CDs in the CD slot

If you try to load a 8 cm (3 in.) CD with its adapter into the unit, the adapter might separate from the CD and damage the unit.

NOTE

- If you experience problems during installation, consult your Kenwood dealer.
- If the unit fails to operate properly, press the Reset button. The unit returns to factory settings when the Reset button is pressed. If the unit still fails to operate properly after the Reset button has been pressed, contact your local KENWOOD dealer for assistance.
- Press the reset button if the disc auto changer fails to operate correctly. Normal operation should be restored.

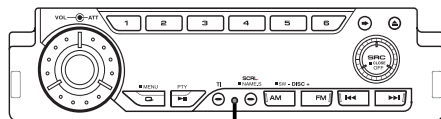

Reset button

- The illustrations of the display and the panel appearing in this manual are examples used to explain more clearly how the controls are used. Therefore, what appears on the display in the illustrations may differ from what appears on the display on the actual equipment, and some of the illustrations on the display may represent something impossible in actual operation.

Lens Fogging

Right after you turn on the car heater in cold weather, dew or condensation may form on the lens in the CD player of the unit. Called lens fogging, CDs may be impossible to play. In such a situation, remove the disc and wait for the condensation to evaporate. If the unit still does not operate normally after a while, consult your Kenwood dealer.

Notes

Cleaning the Unit

If the faceplate of this unit is stained, wipe it with a dry soft cloth such as a silicon cloth.

If the faceplate is stained badly, wipe the stain off with a cloth moistened with neutral cleaner, then wipe neutral detergent off.



- Applying spray cleaner directly to the unit may affect its mechanical parts. Wiping the faceplate with a hard cloth or using a volatile liquid such as thinner or alcohol may scratch the surface or erase characters.

Cleaning the Faceplate Terminals

If the terminals on the unit or faceplate get dirty, wipe them with a dry, soft cloth.

Cleaning the CD Slot

As dust tends to accumulate in the CD slot, clean it every once in a while. Your CDs can get scratched if you put them in a dusty CD slot.

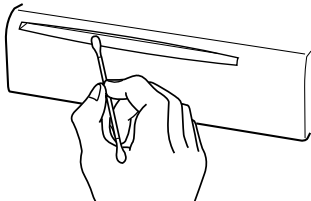

WOW, SRS and  symbol are trademarks of SRS Labs, Inc.

WOW technology is incorporated under license from SRS Labs, Inc.

The marking of products using lasers (Except for some areas)

**CLASS 1
LASER PRODUCT**

The label is attached to the chassis/case and says that the component uses laser beams that have been classified as Class 1. It means that the unit is utilizing laser beams that are of a weaker class. There is no danger of hazardous radiation outside the unit.

This Product is not installed by the manufacturer of a vehicle on the production line, nor by the professional importer of a vehicle into an EU Member State.

Dolby Pro Logic II

The matrix decoding technologies that have been evolved from the conventional Dolby Pro Logic system and that is based on the latest digital matrix technologies. It realizes the excellent 5.1-channel sound playback of Dolby Surround and ordinary CD stereo sounds. You can enjoy surround channels as full-band sounds (from 20 Hz to 20 kHz) and stereo sources as real 5.1-channel sounds. The Movie mode, Music mode, Matrix mode, can be selected according to the playback source. When the Dolby Pro Logic II mode is selected, the sound level is slightly dropped due to its characteristics.

Manufactured under license from Dolby Laboratories.

"Dolby", "Pro Logic", and the double-D symbol are trademarks of Dolby Laboratories.

About CDs

Handling CDs

- Don't touch the recording surface of the CD.



- CD-R and CD-RW are easier to damage than a normal music CD. Use a CD-R or a CD-RW after reading the caution items on the package etc.
- Don't stick tape etc. on the CD.
Also, don't use a CD with tape stuck on it.

When using a new CD

If the CD center hole or outside rim has burrs, use it after removing them with a ball pen etc.

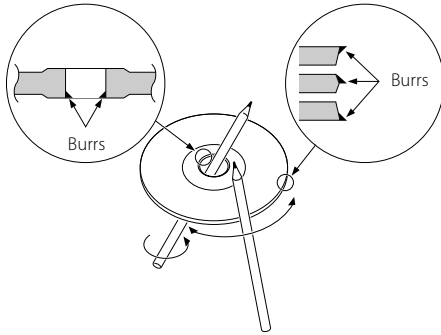

CD accessories

Don't use disc type accessories.

CD cleaning

Clean from the center of the disc and move outward.

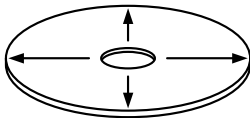

Removing CDs

When removing CDs from this unit pull them out horizontally.

CDs that can't be used

- CDs that aren't round can't be used.

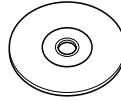

- CDs with coloring on the recording surface or that are dirty can't be used.
- This unit can only play the CDs with



It may not correctly play discs which do not have the mark.

- A CD-R or CD-RW that hasn't been finalized can't be played. (For the finalization process refer to your CD-R/CD-RW writing software, and your CD-R/CD-RW recorder instruction manual.)

CD storage

- Don't place them in direct sunlight (On the seat or dashboard etc.) and where the temperature is high.
- Store CDs in their cases.

Notes on playing MP3/WMA

Note, however, that the MP3/WMA recording media and formats acceptable are limited. When writing MP3/WMA, pay attention to the following restrictions.

Acceptable media

The MP3/WMA recording media acceptable to this unit are CD-ROM, CD-R, and CD-RW. When using CD-RW, do full format not quick format to prevent malfunction.

Acceptable medium formats

The following formats are available for the media used in this unit. The maximum number of characters used for file and folder name including the delimiter (".") and three-character extension are indicated in parentheses.

- ISO 9660 Level 1 (12 characters)
- ISO 9660 Level 2 (31 characters)
- Joliet (64 character)
(KDC-W8027; Up to 32 characters are displayed)
- Romeo (128 character)
(KDC-W8027; Up to 64 characters are displayed)
- Long file name (200 characters)
(KDC-W8027; Up to 64 characters are displayed)
- Maximum number of characters for folder name: 64
(KDC-W8027; Joliet: Up to 32 characters are displayed)

For a list of available characters, see the instruction manual of the writing software and the section Entering file and folder names below.

The media reproducible on this unit has the following limitations:

- Maximum number of directory levels: 8
- Maximum number of files per folder: 255
- Maximum number of folders:
KDC-PSW9527/W9027; 100
KDC-W8027; 50
- Maximum number of files and folders
(KDC-W8027): 512

MP3/WMA written in the formats other than the above may not be successfully played and their file names or folder names are not properly displayed.

Settings for your MP3/WMA encoder and CD writer

Do the following setting when compressing audio data in MP3/WMA data with the MP3/WMA encoder.

- Transfer bit rate: MP3: 8 —320 kbps
WMA: 48 —192 kbps
- Sampling frequency
MP3: 8, 11.025, 12, 16, 22.05, 24, 32, 44.1, 48 kHz
WMA: 32, 44.1, 48 kHz

When you use your CD writer to record MP3/WMA up to the maximum disc capacity, disable additional writing. For recording on an empty disc up to the maximum capacity at once, check Disc at Once.



- Play mode may not be possible when portions of the functions of Windows Media Player 9 or higher are used.

Entering ID3 tag

The Displayable ID3 tag is ID3 version 1.x.

For the character code, refer to the List of Codes.

0	1	2	3	4	5	6	7	8	9	A	B	C	D	E	F
			0	@	P	i	p			■	°	A	D	ä	d
1			!	1	A	Q	a	q		i	±	Ä	N	ä	ñ
2			"	2	B	R	b	r		c	²	Á	O	á	ó
3			#	3	C	S	c	s		£	³	À	Ö	ä	õ
4			\$	4	D	T	d	t		¤	³	Á	Ö	ä	õ
5			%	5	E	U	e	u		¥	µ	À	Ö	ä	õ
6			&	6	F	V	f	v		¦	¶	Æ	Ö	æ	±
7			'	7	G	W	g	w		§	·	Ç	X	ç	±
8			(8	H	X	h	x		¨	¸	È	Ö	è	õ
9)	9	I	Y	i	y		©	¹	É	Ü	é	ü
A			*	:	J	Z	j	z		ª	º	Ê	Ü	ê	ü
B			+	:	K	\	k	\		»	»	Ë	Ü	ë	ü
C			<	.	L	\	l	\		¼	¼	Ì	Ü	ì	ü
D			=	.	M	\	m	\		½	½	Ý	Û	ý	Û
E			>	.	N	^	n	~		¾	¾	Þ	Û	þ	Û
F			/	?	O	_	o	■		—	—	Û	I	B	I

Entering file and folder names

The code list characters are the only file names and folder names that can be entered and displayed.

If you use any other character for entry, the file and folder names are not displayed correctly. They may neither be displayed correctly depending on the CD writer used.

The unit recognizes and plays only those MP3/WMA which have the MP3/WMA extension (.MP3/.WMA).



- A file with a name entered with characters not on the code list may not play correctly.

Writing files into a medium

When a medium containing MP3/WMA data is loaded, the unit checks all the data on the medium. If the medium contains a lot of folders or non-MP3/WMA files, therefore, it takes a long time until the unit starts playing MP3/WMA.

In addition, it may take time for the unit to move to the next MP3/WMA file or a File Search or Folder Search may not be performed smoothly.



Loading such a medium may produce loud noise to damage the speakers.

- Do no attempt to play a medium containing a non-MP3/WMA file with the MP3/WMA extension.
The unit mistakes non-MP3/WMA files for MP3/WMA data as long as they have the MP3/WMA extension.
- Do not attempt to play a medium containing non MP3/WMA.

MP3/WMA playing order

When selected for play, Folder Search, File Search, or for Folder Select, files and folders are accessed in the order in which they were written by the CD writer.

Because of this, the order in which they are expected to be played may not match the order in which they are actually played. You may be able to set the order in which MP3/WMA are to be played by writing them onto a medium such as a CD-R with their file names beginning with play sequence numbers such as "01" to "99", depending on your CD writer.

For example, a medium with the following folder/file hierarchy is subject to Folder Search, File Search, or Folder Select as shown below.

Example of a medium's folder/file hierarchy

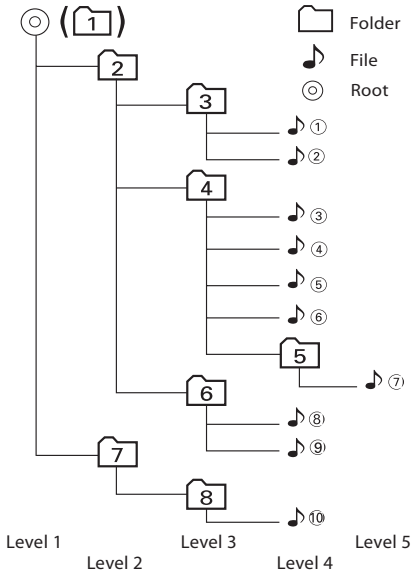

When a File Search is executed with file ④ being played ...

Operation of the button	(Current file: ④)
⏮ Button	Beginning of file ④ → ③
⏭ Button	⑤ → ⑥

When a Folder Search is executed with file ④ being played ...

Operation of the button	(Current folder: ④)
AM Button	③ → ② → ① → ⑧ ...
FM Button	⑤ → ⑥ → ⑦ → ⑧ → ① ...

When Folder Select is selected with file ④ being played to move from folder to folder ...

Operation of the button	(Current folder: ④)
⏮ Button	③
⏭ Button	⑥
AM Button	②
FM Button	⑤

Notes on Multi-function Key System

Multi-function Key System serves to control various functions with the [2] — [5] buttons.

The basic operation of the Multi-function Key System is described below.

What's the Multi-function Key System?

This unit is equipped with the Multi-function Key System that enables the operation of multiple functions with one button.

For example, you can enter the Display Control Mode or turn ON/OFF the Random Play by pressing the [3] button during CD play.

Setting each function

The function display will show the controllable function of the [2] — [5] button above the button. Pressing the [2] — [5] button below the desired function enables the setting of the function.

Displaying the desired function

If five or more functions are available to be set with the [2] — [5] button, they are divided into multiple function groups (referred to as sections in this manual) for registration.

Press the [NEXT] button to switch the sections.

If the display of the desired function is not shown, press the [NEXT] button 1 to 3 times to switch the sections until the wanted function display is shown.

Example: Function display of CD & External disc source

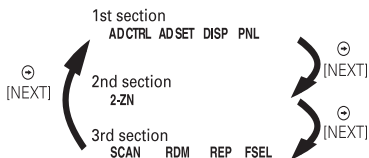

- "MRDM", "H-F", "SYNC" or "DISP" are displayed when an optional accessory is connected.

Real operational example of the Multi-function Key System

Example: Turning ON/OFF the Random Play during CD play.

1. Show the function display of the Random Play.
If "RDM" is not shown in the display, press the [NEXT] button to switch the sections until the "RDM" function display is shown above the [3] button.
2. Turn ON/OFF the Random Play.
Press the [3] button.
Each time the [3] button under the "RDM" function display is pressed the Random Play is turned ON/OFF.

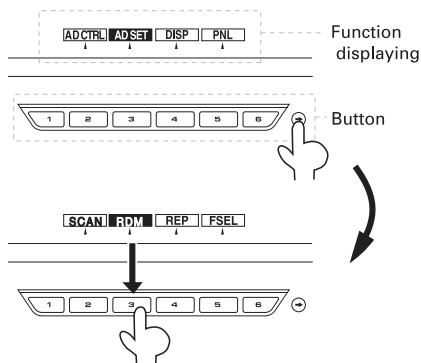

Notes on Sound Management System

The KDC-PSW9527/W9027 allows you to set up the best sound field to your car using the audio setup. This is the Sound Management System.

There are two types of audio setup mode: Easy audio setup (called Easy mode) and Professional audio setup (called PRO mode).

Audio setup (Easy mode)

When you select the cabin size and the speaker type you are using in the easy audio setup (Easy mode), you can set the best sound field to your car automatically.



- Refer to 'Audio Setup (Easy mode)' (page 28).

Audio setup (PRO mode)

While in the professional audio setup (PRO mode), you can fine-tune and memory the X'Over (Cross-over), DTA (Digital Time Alignment), and EQ (Equalizer), controls in addition to the sound quality you have set in the audio setup (Easy mode).



- Refer to 'Audio Setup (PRO mode)' (page 30).

First, set up the sound field in your car by 'Audio setup (Easy mode)' (page 28). Proceed to the following steps for sound field setup.

1. Enter Audio Setup mode.
Press the [NEXT] button.
Repeatedly press the button until "AD SET" is displayed above the [3] button.
Refer to 'Notes on Multi-function Key System' (page 10).
2. Set the cabin size of your car.
Press the [2] ("CABIN") button.
3. Select the cabin size of your car.
Press the [◀◀] or [▶▶] button.
4. Select a speaker
Press the [3] ("SP-SEL") button.
5. Set up the speaker
Press the [2] — [5] button.



- For the speakers you can set up using buttons [2] to [5], see the 'Audio setup (Easy mode)' (page 28).
6. Select the speaker size.
Press the [◀◀] or [▶▶] button.
 7. Exit Audio setup mode
Press the [6] ("RTN") button.

Now, you can create the best sound field to your car.

For the detailed speaker setup, see the 'Audio Setup (PRO mode)' (page 30).

General features

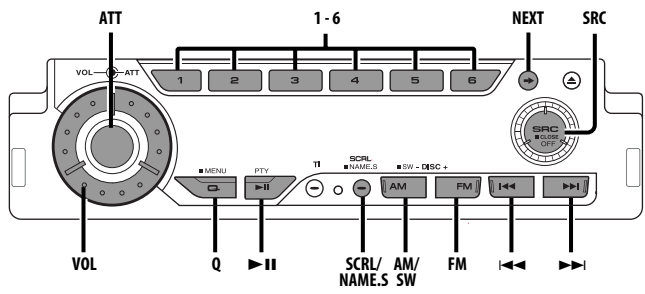

Power

Turning ON the Power

Turn the vehicle ignition ON.

The panel appears.



- When the power is ON, the 'Security Code' (page 46) is displayed as "CODE ON" or "CODE OFF".

Turning OFF the Power

Turn the vehicle ignition OFF or press the [SRC] button for at least 1 second.

The panel hides.



- Do not apply force to the panel during operation. It can cause damage.

Hiding the Control Panel

Prevents tampering with the unit while your car is being serviced etc.

Hiding the control panel

Press the [SRC] button for at least 1 second.

When the time set in 'OFF Wait Time Setting' (page 49) lapses, the panel is hidden and the power turns OFF.

Showing the control panel

Press the left part at the lower side of the panel.

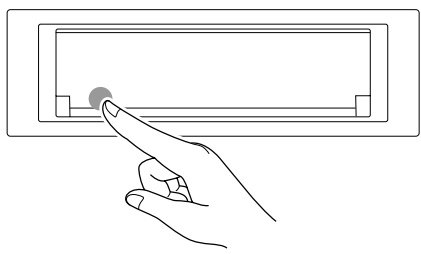

The panel is opened to enable the operation.

Selecting the Source

Press the [SRC] button.

Source required	Display
Tuner	"TUNER"
CD	"Compact Disc"
External disc (Optional accessory)	"CD Changer"
Auxiliary input	"AUX"
Standby (Illumination only mode)	"STANDBY"



- This unit automatically turns full power OFF after 20 minutes lapses in Standby mode in order to save the vehicles battery. The time until full power OFF can be set in 'Power OFF Timer' (page 52).

Volume

Increasing Volume

Turn the [VOL] knob clockwise.

Decreasing Volume

Turn the [VOL] knob counterclockwise.

Attenuator

Turning the volume down quickly.

Press the [ATT] button.

Each time the button is pressed the Attenuator turns ON or OFF.

When it's ON, "ATT" is displayed.

Rotary Volume knob operation mode select

The rotary volume knob can be used for volume adjustment and various function setups.

Available setup functions

The rotary volume knob can be used for the following setup:

- Menu system : Item selection
- Audio Control : Adjustment of setup value
- Audio Setup : Adjustment of setup value
- Display control : Display switching
- Disc Naming : Character selection
- Folder select : Folder search



- You can select the Rotary Volume Operation mode only when the "Jog" indicator is displayed above the [1] button during any function setup.
- When the "Jog" indicator is ON, you cannot use the rotary volume control for function setup and sound level adjustment.

To use the rotary volume knob:

1 Turn the rotary volume operation ON

See the 'Rotary volume operation select' (54 page) and select "Rotary SEL: ON".

2 Selecting the Rotary Volume Operation mode

Press the [1] button.

When it's ON, the "Jog" indicator blinks.

3 Setting the function

Rotate the Rotary Volume knob.

4 Terminates the function setup using the rotary volume knob

Press the [1] button.

General features

Display Mode Switching

Switching the display mode.

1 Select the key function section

Press the [NEXT] button.

Repeatedly press the button until "DISP" is displayed above the [3] (KDC-W8027)/ [4] (KDC-PSW9527/W9027) button.

Refer to 'Notes on Multi-function Key System' (page 10).

2 Enter display control mode

Press the [3] ("DISP") (KDC-W8027)/ [4] ("DISP") (KDC-PSW9527/W9027) button.

3 Select the display mode

Press the [2] ("MODE") button.

Each time the button is pressed the display mode switches as shown below.

Display Mode	Display
"Display:A"	
"Display:B"	
"Display:C"	
"Display:D"	

- ① Side graphic part
- ② Upper text display part
- ③ Lower text display part
- ④ Function item display
- ⑤ Text display part
- ⑥ Graphic & spectrum analyzer display part

4 Exit display control mode

Press the [6] ("RTN") button.



- No function item is displayed if "Display:C" or "Display:D" is selected. To use a function item, press any of [1] to [6] buttons or [NEXT] button. The function item will be displayed approximately 5 seconds.

- When the 'Dual Zone System' (page 24) is ON, the spectrum analyzer cannot be displayed.
- The display is dimmed during "Display:B" or "Display:C" mode.
- The indicator appears only when the Clock is displayed in the upper or lower position during "Display:A" mode.

Display:A

Text Display Switching

Switching the text display.

1 Select the key function section

Press the [NEXT] button.

Repeatedly press the button until "DISP" is displayed above the [3]/ [4] button.

Refer to 'Notes on Multi-function Key System' (page 10).

2 Enter display control mode

Press the [3]/ [4] ("DISP") button.

3 Select the display mode

Press the [2] ("MODE") button.

Select the "Display:A" display.

4 Enter text select mode

Press the [3] ("TEXT") button.



- In the Rotary Volume Operation mode, you can select the Upper part or Lower part using button [3] ("TEXT") and switch the display using the rotary volume key.

5 Select the text in the upper text display part

Press the [FM] or [AM] button.

Select the text in the lower text display part

Press the [◀◀] or [▶▶] button.

Refer to the table described later for setting items.

6 Exit Display Control mode

Press the [6] ("RTN") button.



- The setting of this function is available while "Display:A" is selected for the Display mode.
- Upper text display part cannot display the same information as Lower text display part.
- The Album name cannot be displayed during WMA play.

The text display in the Upper text display part

In Tuner source

Information	Display
Program Service name or Frequency	"BAND+ch+PS"
Radio text or Frequency	"R-TEXT"
Date	"DATE"
Clock	"CLOCK"
Spectrum Analyzer & Clock	"S/ANA+CLOCK"

Displaying the frequency during Program Service name reception

Press the [SCRL] button for at least 1 second.

The frequency for the RDS station will be displayed for 5 seconds instead of the Program Service name.

In CD & External disc source

Information	Display
Disc title	"DISC-TITLE"
Track title	"TRACK-TITLE"
Track number & Play time	"P-Time"
Disc name	"DNPS"
Date	"DATE"
Clock	"CLOCK"
Spectrum Analyzer & Clock	"S/ANA+CLOCK"

In MP3/WMA source

Information	Display
Song title & Artist name	"TITLE/ARTIST"
Album name & Artist name	"ALBUM/ARTIST"
Folder name	"FOLDER NAME"
File name	"FILE NAME"
Play time & File number	"P-Time"
Date	"DATE"
Clock	"CLOCK"
Spectrum Analyzer & Clock	"S/ANA+CLOCK"

In Standby

Information	Display
Standby (Illumination only mode)	"STANDBY"
Date	"DATE"
Clock	"CLOCK"

In Auxiliary input source

Information	Display
Auxiliary input name	"AUX NAME"
Date	"DATE"
Clock	"CLOCK"
Spectrum Analyzer & Clock	"S/ANA+CLOCK"



- If the Disc title, Track title, Song title & Artist name, or Album name & Artist name is selected when the disc which does not have Disc title, Track title, Song title, Album name, or Artist name is played, track number and play time are displayed.

General features

The text display in the Lower text display part

In Tuner source

Information	Display
KENWOOD Logo	"LOGO"
Clock	"CLOCK"
Spectrum Analyzer & Clock	"S/ANA+CLOCK"
Radio text	"R-TEXT"
Date	"DATE"

In CD & External disc source

Information	Display
KENWOOD Logo	"LOGO"
Clock	"CLOCK"
Spectrum Analyzer & Clock	"S/ANA+CLOCK"
Disc title	"DISC-TITLE"
Track Title	"TRACK-TITLE"
Disc name	"DNPS"
Date	"DATE"

In MP3/WMA source

Information	Display
KENWOOD Logo	"LOGO"
Clock	"CLOCK"
Spectrum Analyzer & Clock	"S/ANA+CLOCK"
Song title & Artist name	"TITLE/ARTIST"
Album name & Artist name	"ALBUM/ARTIST"
Folder name	"FOLDER NAME"
File name	"FILE NAME"
Date	"DATE"

In Standby

Information	Display
KENWOOD Logo	"LOGO"
Clock	"CLOCK"
Date	"DATE"

In Auxiliary input source

Information	Display
KENWOOD Logo	"LOGO"
Clock	"CLOCK"
Spectrum Analyzer & Clock	"S/ANA+CLOCK"
Date	"DATE"



- If 'Dual Zone System' (page 24) is turned ON while the spectrum analyzer is displayed, the spectrum analyzer disappears from the display.

- If the Disc title, Track title, Song title & Artist name, or Album name & Artist name is selected when the disc which does not have Disc title, Track title, Song title, Album name, or Artist name is played, Kenwood Logo are displayed.

Display:A

Side Graphic Display Switching

Switching the Side graphic Display.

1 Select the key function section

Press the [NEXT] button.

Repeatedly press the button until "DISP" is displayed above the [3]/ [4] button.

Refer to 'Notes on Multi-function Key System' (page 10).

2 Enter display control mode

Press the [3]/ [4] ("DISP") button.

3 Select the display mode

Press the [2] ("MODE") button.

Select the "Display:A" display.

4 Enter display control mode

Press the [4] ("SIDE") button.

"Side Graphic" is displayed.

5 Select the side graphic display

Press the [◀◀] or [▶▶] button.

Each time the button is pressed the side graphic display switches as shown below.

Side graphic display
Text + Source
Graphic 1
⋮
Graphic 3
Spectrum analyzer 1
⋮
Spectrum analyzer 4
Blank

6 Exit display control mode

Press the [6] ("RTN") button.



- The setting of this function is available while "Display : A" is selected for the Display mode.

Display:B/ Display:C/ Display:D

Graphic part/ Spectrum Analyzer Display Switching

Switching the graphic Display/ Spectrum analyzer display.

1 Select the key function section

Press the [NEXT] button.

Repeatedly press the button until "DISP" is displayed above the [3]/ [4] button.

Refer to 'Notes on Multi-function Key System' (page 10).

2 Enter display control mode

Press the [3]/ [4] ("DISP") button.

3 Select the display mode

Press the [2] ("MODE") button.

Select the "Display:B"/ "Display:C"/ "Display:D" display.

4 Select the graphic/ spectrum analyzer display

Press the [4] ("SA-grph") button.

5 Select the graphic/ spectrum analyzer display part display

Press the [◀◀] or [▶▶] button.

Each time the button is pressed the graphic display/ spectrum analyzer display switches as shown below.

Graphic display/ Spectrum Analyzer display

Movie 1

Movie 2

*Downloaded movie

Spectrum analyzer 1

⋮

Spectrum analyzer 5

Wallpaper

• * Function of the KDC-PSW9527

6 Exit display control mode

Press the [6] ("RTN") button.



• The setting of this function is available while "Display : B"/ "Display:C"/ "Display:D" is selected for the Display mode.

Display:B/ Display:C/ Display:D

Wallpaper selecting

Select a wallpaper to display when Display Type is set to "Display:B"/ "Display:C"/ "Display:D".

1 Select the wallpaper display

Refer to 'Graphic part/ Spectrum Analyzer Display Switching' (page 17).

2 Select the wallpaper

Display the wallpapers one after another and select one

1 Turn the wallpaper scan ON.

Press the [▶▶] button.

Each time the button is pressed the Wallpaper scan is turned ON and OFF.

When it's ON, "SCAN" is displayed.

When it's ON, each wallpaper is displayed every several seconds.

2 At the wallpaper you want to display.

Press the [▶▶] button.

Select wallpaper manually

1 Turn the wallpaper scan OFF.

Press the [▶▶] button.

Each time the button is pressed the Wallpaper scan is turned ON and OFF.

2 Select the wallpaper.

Press the [FM] or [AM] button.

Each time the button is pressed the wallpaper changes.

3 Exit Display Control mode

Press the [6] ("RTN") button.

General features

Display:B/ Display:C

Text Display Switching

Switching the text display.

1 Select the key function section

Press the [NEXT] button.

Repeatedly press the button until "DISP" is displayed above the [3]/ [4] button.

Refer to 'Notes on Multi-function Key System' (page 10).

2 Enter display control mode

Press the [3]/ [4] ("DISP") button.

3 Select the display mode

Press the [2] ("MODE") button.

Select the "Display:B"/ "Display:C" display.

4 Select the text

Press the [3] ("TEXT") button.



- It can also be switched by pressing either [◀◀] or [▶▶] button.

In Tuner source

Information	Display
Program Service name or Frequency	"BAND+ch+PS"
Radio text	"R-TEXT"
Date	"DATE"
Clock	"CLOCK"

Displaying the frequency during Program Service name reception

Press the [SCRL] button for at least 1 second.

The frequency for the RDS station will be displayed for 5 seconds instead of the Program Service name.

In CD & External disc source

Information	Display
Disc title (In External disc source)	"DISC-TITLE"
Track title	"TRACK-TITLE"
Track number & Play time	"P-Time"
Disc name	"DNPS"
Date	"DATE"
Clock	"CLOCK"

In MP3/WMA source

Information	Display
Song title & Artist name	"TITLE/ARTIST"
Album name & Artist name	"ALBUM/ARTIST"
Folder name	"FOLDER NAME"
File name	"FILE NAME"
Play time & File number	"P-Time"
Date	"DATE"
Clock	"CLOCK"

In Auxiliary input source

Information	Display
Auxiliary input name	"AUX NAME"
Date	"DATE"
Clock	"CLOCK"

In Standby

Information	Display
Standby (Illumination only mode)	"STANDBY"
Date	"DATE"
Clock	"CLOCK"

5 Exit Display Control mode

Press the [6] ("RTN") button.



- If the Disc title, Track title, Song title & Artist name, or Album name & Artist name is selected when the disc which does not have Disc title, Track title, Song title, Album name, or Artist name is played, track number and play time are displayed.

External Display Switching

Switching the display in the External Display connected.

1 Select the key function section

Press the [NEXT] button.

Repeatedly press the button until "DISP" is displayed above the [3]/ [4] button.

Refer to 'Notes on Multi-function Key System' (page 10).

2 Enter display control mode

Press the [3]/ [4] ("DISP") button.

3 Select the display

Press the [5] ("OUT") button.

"Disp Out Select" is displayed.
Each time the button is pressed the display switches.

4 Exit display control mode

Press the [6] ("RTN") button.

Auxiliary Input Display Setting

Selecting the display when this device is switched to Auxiliary input source.

1 Select Auxiliary input source

Press the [SRC] button.

Select the "AUX" display.

2 Enter Auxiliary input display setting mode

Press the [NAME.S] button for at least 2 seconds.

The presently selected AUX Name is blinks.

3 Select the Auxiliary input display

Press the [◀◀] or [▶▶] button.

Each time the button is pressed it switches through the below displays.

- "AUX"
- "TV"
- "VIDEO"
- "GAME"
- "PORTABLE"
- "DVD"

4 Exit Auxiliary input display setting mode

Press the [NAME.S] button.



- When operation stops for 10 seconds, the name at that time is selected, and Auxiliary input display setting mode closes.
- The Auxiliary Input Display can be set only when the built-in auxiliary input or the auxiliary input of optional KCA-S210A is used.

Panel Position Setting

Setting the angle or back-forward position of the control panel.

1 Select the key function section

Press the [NEXT] button.

Repeatedly press the button until "PNL" is displayed above the [4]/ [5] button.

2 Enter Panel Position Setting mode

Press the [4] ("PNL") (KDC-W8027)/ [5] ("PNL") (KDC-PSW9527/W9027) button.

3 Select the item for adjustment

Press the desired [2] — [5] button.

Each time the button is pressed the items that can be adjusted switch as shown below.

Adjustment Item	Button	Display
The panel tilts upwards.	[2]	"ANG—"
The panel tilts downwards.	[3]	"ANG+"
The panel slides backward.	[4]	"SLD—"
The panel slides forward.	[5]	"SLD+"

4 Exit Panel Position Setting mode

Press the [6] ("RTN") button.



- The control panel may be interfered with the shift lever or another part depending on the angles of the control panel.
Set the angle to avoid any interference.
- When a hard rubber frame is mounted
Do not use with the panel slid in the forward direction.
If so, the hard rubber frame will interfere with the panel when the angle is adjusted downward.
- No sound is produced while the panel is operating.

General features

Theft Deterrent Panel

The Backpanel of the unit can be detached and taken with you, helping to deter theft.

Removing the Backpanel

1 Turn the ignition OFF or press the [SRC] button for at least 1 second.

Turn OFF the power, and the control panel becomes horizontal.



- After the set time passes in 'OFF Wait Time Setting' (page49), the panel is closed.

2 Remove the Backpanel forward.

When 'DSI (Disabled System Indicator)' (page49) is set to ON, DSI blinks.

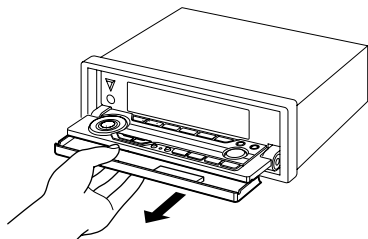

- The back panel is a precision piece of equipment and can be damaged by shocks or jolts. For that reason, keep the back panel in its special storage case while detached.
- Do not expose the Backpanel or its storage case to direct sunlight or excessive heat or humidity. Also avoid places with too much dust or the possibility of water splashing.

Reattaching the Backpanel

1 Set the Backpanel to the panel bracket.

2 Hold down on the Backpanel until it is locked.

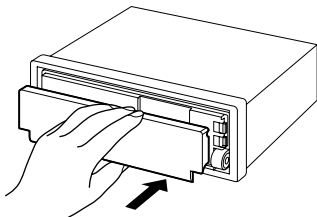

TEL Mute

The audio system automatically mutes when a call comes in.

When a call comes in

"CALL" is displayed.

The audio system pauses.

Listening to the audio during a call

Press the [SRC] button.

The "CALL" display disappears and the audio system comes back ON.

When the call ends

Hang up the phone.

The "CALL" display disappears and the audio system comes back ON.

Function of the KDC-W8027

System Q

You can recall the best sound setting preset for different types of music.

1 Select the source to set

Press the [SRC] button.

2 Select the Sound type

Press the [Q] button.

Each time the button is pressed the sound setting switches.

Sound setting	Display
SRS WOW	"SRS WOW"
Natural	"Natural"
User memory	"USER"
Rock	"ROCK"
Pops	"POPS"
Easy	"EASY"
Top 40	"TOP 40"
Jazz	"JAZZ"



- User memory: The values set on the 'Audio Control' (KDC-W8027) (page 22).
- Each setting value is changed with the 'Speaker Setting' (page 24).
First, select the speaker type with the Speaker setting.
- When 'Dual Zone System' (page 24) is set to ON, the setting of SRS WOW is disabled.

System Q

You can recall the best sound setting preset for different types of music.

1 Select the source to set

Press the [SRC] button.

2 Select the Sound type

Press the [Q] button.

Each time the button is pressed the sound setting switches.

Sound setting	Display
Natural	"Natural"
Rock	"ROCK"
Pops	"POPS"
Easy	"EASY"
Top 40	"TOP 40"
Jazz	"JAZZ"
User memory	"USER"
Installer	"INSTALLER"



- User memory: The values set on the 'Audio Setup (PRO mode)' (page 30).
- Installer: The values set on the 'Audio Setup (PRO mode)' (page 30).
- Each setting value is changed with the 'Audio Setup (PRO mode)' (page 30).

First, select the Cabin size and the speaker type with 'Audio Setup (Easy mode)' (page 28). Refer to 'Notes on Sound Management System' (page 11).

General features

Function of the KDC-W8027

Audio Control

1 Select the source for adjustment

Press the [SRC] button.

2 Select the key function section

Press the [NEXT] button.

Repeatedly press the button until "AUD" is displayed above the [2] button.

Refer to 'Notes on Multi-function Key System' (page 10).

3 Enter Audio Control mode

Press the [2] ("AUD") button.

4 Select the Adjustment item section

Press the [NEXT] button.

Repeatedly press the button until the desired Adjustment item is displayed above the [2] — [5] button.

1st section

Adjustment Item	Button	Display
Bass	[2]	"BASS"
Middle	[3]	"MID"
Treble	[4]	"TRE"
WOW	[5]	"WOW"

2nd section

Adjustment Item	Button	Display
Subwoofer*	[2]	"SW"
High Pass Filter	[3]	"HPF"
Low Pass Filter*	[4]	"LPF"
Loudness	[5]	"LOUD"

3rd section

Adjustment Item	Button	Display
Balance & Fader	[2]	"BL/F"
Volume offset	[3]	"VOFF"

5 Select the Audio Control item for adjustment

Press the [2] — [5] button.

Each time the [2] — [5] button is pressed the adjustable audio items are switched among ranges of all stage section's tables on the following pages.

6 Adjust the Audio Control item

Press the [◀◀] or [▶▶] button.

Each time the button is pressed the setting switches as shown below.



- The Adjustment item can also be controlled by the rotary volume knob. Refer to 'Rotary Volume knob operation mode select'(page 13).

7 Exit Audio Control mode

Press the [6] ("RTN") button.



- The loudness setting can also be adjusted by pressing the [5] button.
- WOW can be set when SRS WOW or User memory is selected at 'System Q' (KDC-W8027) (page 20).
- The Loudness can not be set when SRS WOW is selected at 'System Q' (KDC-W8027) (page 20).
- *This mode is available only when 'Subwoofer Output' (page 25) is ON.

1st section

[2] button

Adjustment Item	Display	Range
Bass Center Frequency	"BASS F"	60/70/80/100 or 150 Hz
Bass level	"BASS L"	-8 — +8 dB
Bass Q Factor	"BASS Q"	1.00/1.25/1.50/2.00
Bass Extend	"BASS Ext"	ON/OFF

[3] button

Adjustment Item	Display	Range
Middle Center Frequency	"MIDDLE F"	0.5/1.0/1.5/2.0 kHz
Middle level	"MIDDLE L"	-8 — +8 dB
Middle Q Factor	"MIDDLE Q"	1.0/2.0

[4] button

Adjustment Item	Display	Range
Treble Center Frequency	"TREBLE F"	10.0/12.5/15.0/17.5 kHz
Treble level	"TREBLE L"	-8 — +8 dB

[5] button

Adjustment Item	Display	Range
SRS WOW	"SRS WOW"	OFF/LOW/HIGH
FOCUS	"FOCUS"	OFF/LOW/HIGH
TruBass	"TruBass"	ON/OFF
SRS 3D	"SRS 3D"	ON/OFF



- According to the Bass Q Factor setting value, the frequencies that can be set in Bass Center Frequency change as shown below.

Bass Q Factor	Bass Center Frequency
1.00/1.25/1.50	60/70/80/100
2.00	60/70/80/150

- When the bass extend is set to ON, low frequency response is extended by 20%.
- WOW: TruBass, FOCUS and SRS 3D are all set to values shown below.

WOW	TruBass	FOCUS	SRS 3D
High	ON	High	ON
Low	ON	Low	ON
OFF	OFF	OFF	OFF

- TruBass: Assisting the playback for the super bass sound.
- FOCUS: Adjusts the sound image by changing the vertical position of the speakers virtually and increases or decreases the soundscape.
- SRS 3D: Making a natural 3D sound field.
- SRS 3D cannot be set in tuner source.

2nd section

[2] button

Adjustment Item	Display	Range
Subwoofer level	"SW LEVEL"	-15 — +15
Subwoofer phase	"PHASE"	Normal (0°)/Reverse (180°)

[3] button

Adjustment Item	Display	Range
Front High Pass Filter	"X'OVER Front"	Through/40/60/80/100/ 120/150/180/220 Hz
Rear High Pass Filter	"X'OVER Rear"	Through/40/60/80/100/ 120/150/180/220 Hz

[4] button

Adjustment Item	Display	Range
Subwoofer Low Pass Filter	"X'OVER Sub Woofer"	50/80/120/Through Hz

[5] button

Adjustment Item	Display	Range
Loudness	"LOUD"	ON/OFF



- Loudness: Compensating for low and high tones during low volume.

3rd section

[2] button

Adjustment Item	Display	Range
Balance	"BL"	Left 15 — Right 15
Fader	"F"	Rear 15 — Front 15

[3] button

Adjustment Item	Display	Range
Volume offset	"VOL OFFSET"	-8 — 0



- Volume offset: Each source's volume can be set as a difference from the basic volume.

General features

Function of the KDC-W8027

Speaker Setting

Fine-tuning so that the System Q value is optimal when setting the speaker type.

1 Enter Standby

Press the [SRC] button.

Select the "STANDBY" display.

2 Enter Speaker Setting mode

Press the [Q] button.

"SP SELECT" is displayed.

3 Select the Speaker type

Press the [2] — [5] button.

Each time the button is pressed the setting switches as shown below.

Speaker type	Button	Display
OFF	[2]	"OFF"
For 5 & 4 in. speaker	[3]	"5/4"
For 6x9 & 6 in. speaker	[4]	"6*9/6"
For the OEM speaker	[5]	"OEM"

4 Exit Speaker Setting mode

Press the [Q] button.

In External disc, or Auxiliary input source

Dual Zone System

Makes the sound different for the front channel and rear channel.

Output the Internal source sound from either one of the front or rear channels, and the sound of other source from the Dual zone channel.

1 Select the source

Press the [SRC] button.

Select the source sound to be output from the Dual zone channel.

2 Select the key function section

Press the [NEXT] button.

Repeatedly press the button until "2-ZN" is displayed above the [5] / [2] button.

Refer to 'Notes on Multi-function Key System' (page 10).

3 Enter the Dual Zone System Control mode

Press the [5] ("2-ZN")(KDC-W8027)/ [2] ("2-ZN")(KDC-PSW9527/W9027) button.

4 Select the item for adjustment

Press the desired [2] — [3] button.

Each time the button is pressed the items that can be adjusted switch as shown below.

Adjustment Item	Button	Display	Range
Dual Zone System	[2]	"ON/OFF"	ON/OFF
Dual Zone System Front & Rear	[3]	"F ↔ R"	Front/Rear



Dual Zone System Rear:

The front is this unit's internal source, and the rear is selected source sound.

Dual Zone System Front:

The rear is this unit's internal source, and the front is selected source sound.

5 Exit the Dual Zone System Control mode

Press the [6] ("RTN") button.

6 Select the source

Press the [SRC] button.

Select the source sound to be output from the internal source channel.



- The Dual Zone System can be used with the sources shown below.
 - Internal auxiliary input
 - KCA-S210A
 - CA-C1AX
 - External disc changer/ player
- While Dual Zone System is ON, the setting of Dual Zone System Front or Rear is disabled.
Set Dual Zone System Front or Rear first, and then set the Dual Zone System to ON.
- When the Dual Zone System is ON, there is no Dual zone channel audio control or other effect.
- When you use the Dual Zone System by selecting the optional accessory source for the output of the Dual zone channel, you cannot select another optional accessory source as the source for the Internal source channel.
- When "SRS WOW" is selected at 'System Q' (KDC-W8027) (page 20) the Dual Zone System cannot be turned on and off.
Also set all the 'Audio Control' (KDC-W8027) (page 22) WOW items to OFF.
The Dual Zone System cannot be turned on and off if even one of the items is set to ON.
- The Dual Zone System cannot be used if a GSM hands free unit or a DAB control unit is connected.

- When the 'Dual Zone System' is ON, each of the following setup is ignored.
 - "WOW"/ "PLII"/ "POSI"/ "PHASE"
(Audio control' (KDC-PSW9527/W9027) (page 26))
 - "X'over"/ "EQ"/ "DTA"
(Audio Setup (PRO mode)' (page 30))
 - System Q
(System Q' (KDC-PSW9527/W9027) (page 21))
 - WOW/ X'OVER
(Audio Control' (KDC-W8027) (page 22))
- The Dual Zone System can be used only when you have set the rear speaker to any mode other than "None" in the 'Audio Setup (Easy mode)' (page 28).

Subwoofer Output

Turning the Subwoofer output ON or OFF.

Press the [SW] button for at least 1 second.

Each time the button is pressed Subwoofer output switches ON or OFF.

When it's ON, "SUB WOOFER ON" is displayed.

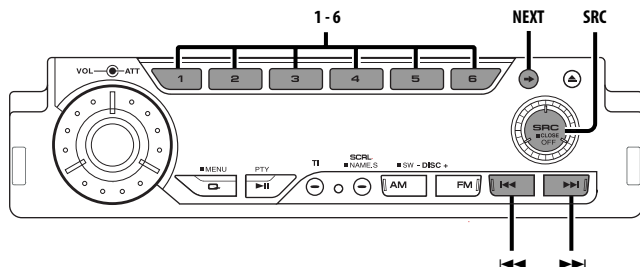

Audio control

1 Select the source for adjustment

Press the [SRC] button.

2 Select the key function section

Press the [NEXT] button.

Repeatedly press the button until "AD CTRL" is displayed above the [2] button.

Refer to 'Notes on Multi-function Key System' (page 10).

3 Enter Audio Control mode

Press the [2] ("AD CTRL") button.

4 Select the Adjustment item section

Press the [NEXT] button.

Repeatedly press the button until the desired Adjustment item is displayed above the [2] — [5] button.

5 Select the Audio Control item for adjustment

Press the [2] — [5] button.

Each time the [2] — [5] button is pressed the adjustable audio items are switched among ranges of all stage section's tables on the following pages.

1st section

Multi-function key operation	Audio control item
[2] "PLII"*	Dolby ProLogic II setting
[3] "WOW"	SRS WOW setting
[4] "OFF"	OFF setting
[5] "FINE"	[2] "PNRM" Panorama setting
	[3] "DIM" Dimension control
	[4] "CT-WDTH" Center width control
	[2] "FOCUS" FOCUS setting
	[3] "TruBass-F" SRS TruBass Front setting
	[3] "TruBass-R" SRS TruBass Rear setting
	[4] "SRS 3D" SRS 3D setting



- When you select the "MUSIC" using "PLII", you can set the "PNRM", "DIM" and "CT-WDTH" using the "FINE" function. Also, when you select the "WOW", you can set the "FOCUS", "TruBass-F/TruBass-R", and "SRS 3D" using the "FINE" function.

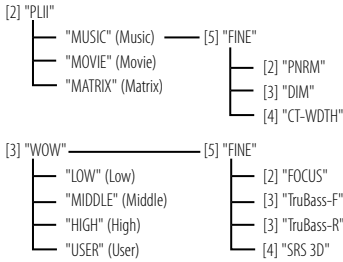

2nd section

Multi-function key operation	Audio control item
[2] "POSI"	Position setting
[3] "BL/F"	[3] "BL" Balance setting [3] "F" Fader setting
[4] "VOFF"	Volume offset
[5] "SW"*2	[5] "SW LEVEL" Subwoofer level [5] "PHASE" Subwoofer Phase setting



- Volume offset: Each source's volume can be set as a difference from the basic volume.
- *2 You can control this item when 'Subwoofer Output' (page 25) is set to "SUB WOOFER ON". Note that you can control it only when "SP-LEV" is set to any item other than "None" by 'Audio Setup (Easy mode)' (page28).

6 Adjust the Audio Control item Press the [◀◀] or [▶▶] button.

Each time the button is pressed the setting switches as shown below.

1st section

Audio Control Item	Range
Dolby ProLogic II setting*	MUSIC/ MOVIE/ MATRIX
SRS WOW setting	LOW/ MIDDLE/ HIGH/ USER
OFF setting	Through/ Bypass
Panorama setting	ON/ OFF
Dimension control	R3 — R1/ Neutral/ F1 — F3
Center width control	0 — 7
FOCUS setting	OFF/ 1 — 9
SRS TruBass Front setting	OFF/ 1 — 4
SRS TruBass Rear setting	OFF/ 1 — 4
SRS 3D setting	OFF/ 1 — 4

2nd section

Audio Control Item	Range
Position setting	ALL/ Front-L/ Front-R/ Front
Balance setting	L15 — R15
Fader setting	R15 — F15
Volume offset	-8 — 0
Subwoofer level	-10 — +10
Subwoofer Phase setting	Normal/ Reverse



- * Function of the KDC-PSW9527
- The Adjustment item can also be controlled by the rotary volume knob. Refer to 'Rotary Volume knob operation mode select' (page 13).
- When the 'Dual Zone System' (page 24) is ON, each of the following setup is ignored.
 - "WOW"/ "PLII"/ "POSI"/ "PHASE"
- WOW: TruBass, FOCUS and SRS 3D are all set to values shown below.

WOW	FOCUS	TruBass	SRS 3D
HIGH	8	4	4
MIDDLE	6	3	2
LOW	3	2	1

- FOCUS: Adjusts the sound image by changing the vertical position of the speakers virtually and increases or decreases the soundscape.
- TruBass: Assisting the playback for the super bass sound.
- SRS 3D: Making a natural 3D sound field.
- SRS 3D cannot be set in tuner source.
- The Dimension Control can be set only when the rear speaker is ON.
- The Center Width Control can be set only when the center speaker is ON.
- Before you set the "TruBass-F"/ "TruBass-R" to get the best sound, set the speaker size using the 'Audio Setup (Easy mode)' (page 28) function. Refer to 'Notes on Sound Management System' (page 11).

7 Exit Audio Control mode

Press the [6] ("RTN") button.

Audio Setup (Easy mode)

1 Selects the Easy mode of Audio setup

See the 'Audio Setup' (page 50) and select "Audio Setup: Easy".

2 Select the source for adjustment

Press the [SRC] button.

3 Select the key function section

Press the [NEXT] button.

Repeatedly press the button until "AD SET" is displayed above the [3] button.

Refer to 'Notes on Multi-function Key System' (page 10).

4 Enter Audio Setup mode

Press the [3] ("AD SET") button.

5 Select the Audio Setup item for adjustment

Press the [2] — [5] button.

Each time the [2] — [5] button is pressed the adjustable audio items are switched among ranges of all stage section's tables on the following pages.

Function of the KDC-W9027

Multi-function key operation	Audio setup item
[2] "CABIN"	Cabin setting
[3] [2] "FRONT" "SP-SEL" [3] "REAR" [4] "SW"	Speaker select Front Speaker select Rear Speaker select Subwoofer
[4] [2] "FRONT" [2] "Front-L" "SP-LEV" [2] "Front-R" [3] "REAR" [3] "Rear-L" [3] "Rear-R" [4] "SW" [5] "T-TONE"*	Speaker level Front Left Speaker level Front Right Speaker level Rear Left Speaker level Rear Right Speaker level Subwoofer Speaker level Test tone
[5] [2] "USER" "CALL" [3] "INST"	Call User Call Installer

Function of the KDC-PSW9527

Multi-function key operation	Audio setup item
[2] "CABIN"	Cabin setting
[3] [2] "FRONT" "SP-SEL" [3] "REAR" [4] "CNTR" [5] "SW"	Speaker select Front Speaker select Rear Speaker select Center Speaker select Subwoofer
[4] [2] "FRONT" [2] "Front-L" "SP-LEV" [2] "Front-R" [3] "REAR" [3] "Rear-L" [3] "Rear-R" [4] "CT/SW" [4] "Center" [4] "SubWoofr"	Speaker level Front Left Speaker level Front Right Speaker level Rear Left Speaker level Rear Right Speaker level Center Speaker level Subwoofer
[5] [2] "USER" "CALL" [3] "INST"	Call User Call Installer



- You can recall the value you have adjusted in the Audio setup PRO mode by selecting the "CALL". Refer to 'Audio Setup memory Recall' (page 32).
- * You can listen to the "T-TONE" when you have tuned it. The sound level is reduced when "T-TONE" is selected. The sound returns to the normal level when the original source is selected.

6 Adjust the Audio setup item

Press the [◀◀] or [▶▶] button.

Each time the button is pressed the setting switches as shown below.

Audio setup Item	Range
Cabin setting	OFF/ Compact/ Sedan/ Wagon1/ Wagon2/ MiniVan1/ MiniVan2/ SUV/ Passenger Van
Speaker select Front	O.E.M./ 10/ 13/ 16/ 17/ 18 (cm)/ 4#6/ 5#7/ 6#8/ 6#9/ 7#10 (inch)
Speaker select Rear	None/ O.E.M./ 10/ 13/ 16/ 17/ 18 (cm)/ 4#6/ 5#7/ 6#8/ 6#9/ 7#10 (inch)
Speaker select Center*2	None/ 40#70 (mm)/ 5/ 10/ 13/ 16 Over (cm)
Speaker select Subwoofer	16/ 20/ 25/ 30/ 38 Over (cm)/ None
Speaker level Front Left	-10 — +10
Speaker level Front Right	
Speaker level Rear Left	
Speaker level Rear Right	
Speaker level Center*2	-10 — +10
Speaker level Subwoofer	



- The Adjustment item can also be controlled by the rotary volume knob. Refer to 'Rotary Volume knob operation mode select' (page 13).
- You can select the Speaker level only when you have set the speaker to anything other than "None" using the "SP-SEL".
- *2 Function of the KDC-PSW9527

7 Exit Audio setup mode

Press the [6] ("RTN") button.

Audio Setup (PRO mode)

1 Selects the PRO mode of Audio setup

See the 'Audio Setup' (page 50) and select "Audio Setup: PRO".

2 Select the Audio Setup item for adjustment

Select an audio setup item you wish to adjust by referring to Step 2-5 of 'Audio Setup (Easy mode)' (page 28).

1st section

Function of the KDC-W9027

Multi-function key operation		Audio setup Item
[2] "X'Over"	[2] "FRONT" [3] "REAR" [4] "SW" [4] "PHASE"	High Pass Filter Front High Pass Filter Rear Low Pass Filter Subwoofer Subwoofer Phase setting
[3] "DTA"	[2] "FRONT" [3] "REAR" [4] "SW"	DTA Front DTA Rear DTA Subwoofer
[4] * "EQ"	[2] "FRONT" [3] "REAR" [4] "TRE"* [2] "BASS"* [3] "MID"* [4] "TRE"* [2] "BASS"* [3] "MID"* [4] "TRE"*	EQ Front Bass setting EQ Front Middle setting EQ Front Treble setting EQ Rear Bass setting EQ Rear Middle setting EQ Rear Treble setting
[5] "SP- LEV"	[2] "FRONT" [2] "Front-L" [2] "Front-R" [3] "REAR" [3] "Rear-L" [3] "Rear-R" [4] "SW" [5] "T-TONE"	SP-LEV Front Left SP-LEV Front Right SP-LEV Rear Left SP-LEV Rear Right SP-LEV Subwoofer SP-LEV Test tone

Function of the KDC-PSW9527

Multi-function key operation		Audio setup Item	
[2] "X'Over"	[2] "FRONT" [3] "REAR" [4] "CNTR" [5] "SW" [5] "PHASE"	High Pass Filter Front High Pass Filter Rear High Pass Filter Center Low Pass Filter Subwoofer Subwoofer Phase setting	
[3] "DTA"	[2] "FRONT" [3] "REAR" [4] "CNTR" [5] "SW"	DTA Front DTA Rear DTA Center DTA Subwoofer	
[4] "EQ"	[2] "FRONT" [3] "REAR" [4] "CNTR"	[2] "BASS"* [3] "MID"* [4] "TRE"* [2] "BASS"* [3] "MID"* [4] "TRE"* [2] "BASS"* [3] "MID"* [4] "TRE"*	EQ Front Bass setting EQ Front Middle setting EQ Front Treble setting EQ Rear Bass setting EQ Rear Middle setting EQ Rear Treble setting EQ Center Bass setting EQ Center Middle setting EQ Center Treble setting
[5] "SP- LEV"	[2] "FRONT" [3] "REAR" [4] "CT/SW"	[2] "Front-L" [2] "Front-R" [3] "Rear-L" [3] "Rear-R" [4] "Center" [4] "Sub Woofer"	SP-LEV Front Left SP-LEV Front Right SP-LEV Rear Left SP-LEV Rear Right SP-LEV Center SP-LEV Subwoofer
*2	[5] "T-TONE"	SP-LEV Test tone	



- * The followings can be adjusted each time button [2] "BASS", button [3] "MID" or button [4] "TRE" of "EQ" functions is pressed.
 - [2]"BASS" : "BASS F" (Bass Center Frequency)
"BASS L" (Bass Level)
"BASS Q" (Bass Q Factor)
 - [3]"MID" : "MID F" (Middle Center Frequency)
"MID L" (Middle Level)
"MID Q" (Middle Q Factor)
 - [4]"TRE" : "TRE F" (Treble Center Frequency)
"TRE L" (Treble Level)
"TRE Q" (Treble Q Factor)
- *2 You can listen to the "T-TONE" when you have tuned it. The sound level is reduced when "T-TONE" is selected. The sound returns to the normal level when the original source is selected.
- X'over (Crossover Network Setup)
You can manually set a crossover frequency of speakers.
- DTA (Digital Time Alignment)
Manually set the sound output timing of each channel.
- EQ (Equalizer)
You can manually set the equalizer curve.
- SP-LEV (Speaker Level)
Set the volume at each setup position.

2nd section

Multi-function key operation		Audio setup item
[2]	[2] "USER"	User Memory
"MEMORY"	[3] "INST"	User Installer
[3]	[2] "USER"	Call User
"CALL"	[3] "INST"	Call Installer



- You can store an adjusted audio setup value by selecting "MEMORY". Also, you can recall it by selecting "CALL". Refer to 'Audio Setup memory Recall' (page 32).

3 Adjust the Audio setup item

Press the [◀◀] or [▶▶] button.

Each time the button is pressed the setting switches as shown below.

Adjustment Item	Range
High Pass Filter Front	Through/30 — 250 (Hz)
High Pass Filter Rear	
High Pass Filter Center*3	
Low Pass Filter Subwoofer	30 — 250 (Hz)
Subwoofer Phase setting	Normal/ Reverse
DTA Front/DTA Rear/ DTA Subwoofer	0 — 610 (cm)
DTA Center*3	0 — 170 (cm)
Bass Center Frequency	60 — 400 (Hz)
Middle Center Frequency	500 (Hz) — 3.15 (KHz)
Treble Center Frequency	4.00 (kHz) — 16.00 (KHz)
Bass Level/ Middle Level/ Treble Level	-9 — +9 dB
Bass Q Factor/ Middle Q Factor/ Treble Q Factor	0.25/ 0.50/ 1.00/ 2.00
SP-LEV Front Left/SP-LEV Front Right	-10 — +10
SP-LEV Rear Left/SP-LEV Rear Right	
SP-LEV Center*3/SP-LEV Subwoofer	



- The Adjustment item can also be controlled by the rotary volume knob. Refer to 'Rotary Volume knob operation mode select' (page 13).
- To get the best sound, first set the "CABIN" and "SP-SEL" parameters using the 'Audio Setup (Easy mode)' (page 28). Refer to 'Notes on Sound Management System' (page 11).
- *3 Function of the KDC-PSW9527
- When the 'Dual Zone System' (page 24) is ON, each of the following setup is ignored.
 - "Xover"/ "EQ" / "DTA"

4 Exit Audio setup mode

Press the [6] ("RTN") button.

Audio Setup Memory (PRO mode)

1 Selects the PRO mode of Audio setup

See the 'Audio Setup' (page 50) and select "Audio Setup: PRO".

2 Select the source for adjustment

Press the [SRC] button.

3 Select the key function section

Press the [NEXT] button.

Repeatedly press the button until "AD SET" is displayed above the [3] button.

Refer to 'Notes on Multi-function Key System' (page 10).

4 Enter Audio Setup mode

Press the [3] ("AD SET") button.

5 Select the Adjustment item section

Press the [NEXT] button.

Repeatedly press the button until the desired Adjustment item is displayed above the [2] — [5] button.

6 Select the Audio Setup item for adjustment

Press the [2] — [5] button.

Adjust the audio setup by referring to the 'Audio Setup (PRO mode)' (page 30).

7 Select the Memory item section

Press the [NEXT] button.

Repeatedly press the button until "MEMORY" is displayed above the [2] button.

8 Select the Memory item

Press the [2] ("MEMORY") button.

9 Stores the adjusted audio setup value in memory

Press the [2] ("USER")/ [3] ("INST") button for at least 2 seconds.

The "MEMORY" display blinks 1 time.

"USER": The values are erased from memory if the battery is removed or if the reset button is pressed.

"INST": The values are held in memory even if the battery is removed or if the reset button is pressed.

10 Exit Audio Setup mode

Press the [6] ("RTN") button.

Audio Setup memory Recall

1 Enter Audio Setup mode

Press the [3] ("AD SET") button.

2 Select the Recall section

Press the [NEXT] button.

Repeatedly press the button until "CALL" is displayed above the [3]/[5] button.

3 Call the Audio setup memory and select an item to call the memory value

Press the [3]/ [5] ("CALL") button.



- If you have set the Audio Setup to "Audio Setup: PRO" using 'Audio Setup' (page 50), press button [3]. If you have set the Audio Setup to "Audio Setup: Easy", press button [5].

4 Recalls the value from memory

Press the [2] ("USER")/ [3] ("INST") button.

5 Exit Audio Setup mode

Press the [6] ("RTN") button.

Tuner features

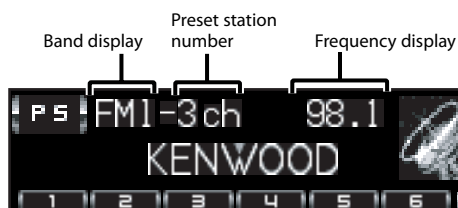
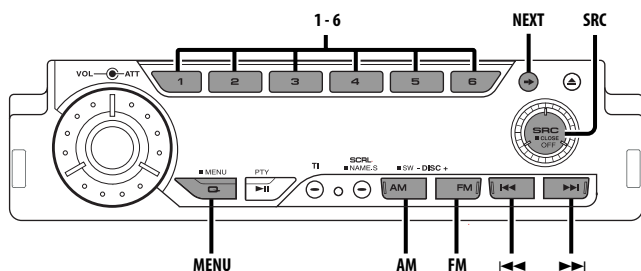

Tuning

Selecting the station.

1 Select tuner source

Press the [SRC] button.

Select the "TUNER" display.

2 Select the band

Press the [FM] or [AM] button.

Each time the [FM] button is pressed it switches between the FM1, FM2, and FM3 bands.

3 Tune up or down band

Press the [◀◀] or [▶▶] button.

Function of remote

Direct Access Tuning

Entering the frequency and tuning.

1 Select the band

Press the [FM] or [AM] button.

2 Enter Direct Access Tuning mode

Press the [DIRECT] button on the remote.

"- - - -" is displayed.

3 Enter the frequency

Press the number buttons on the remote.

Example:

Desired frequency	Press button
92.1 MHz (FM)	[0], [9], [2], [1]
810 kHz (AM)	[0], [8], [1], [0]

Canceling Direct Access Tuning

Press the [DIRECT] button on the remote.

Station Preset Memory

Putting the station in the memory.

1 Select the band

Press the [FM] or [AM] button.

2 Select the frequency to put in the memory

Press the [◀◀] or [▶▶] button.

3 Select the key function section

Press the [NEXT] button.

Repeatedly press the button until "[1]" — "[6]" are displayed above the [1] — [6] buttons.

Refer to 'Notes on Multi-function Key System' (page 10).

4 Put the frequency in the memory

Press the desired [1] — [6] button for at least 2 seconds.

The preset number display blinks 1 time.

On each band, 1 station can be put in the memory on each [1] — [6] button.

Auto Memory Entry

Putting a station with good reception in the memory automatically.

1 Select the band for Auto Memory Entry

Press the [FM] or [AM] button.

2 Enter Menu mode

Press the [MENU] button for at least 1 second. "MENU" is displayed.

3 Select the Auto Memory Entry mode

Press the [FM] or [AM] button.

Select the "Auto Memory" display.

4 Open Auto Memory Entry

Press the [◀◀] or [▶▶] button for at least 2 seconds.

When 6 stations that can be received are put in the memory Auto Memory Entry closes.



- When the 'AF (Alternative Frequency)' (page 51) is ON, only RDS stations are put in the memory.
- When Auto Memory Entry is done in the FM2 band, the RDS stations preset in the FM1 band aren't put in the memory.

Likewise, when it is done in the FM3 band, RDS stations preset in FM1 or FM2 aren't put in the memory.

Preset Tuning

Calling up the stations in the memory.

1 Select the band

Press the [FM] or [AM] button.

2 Select the key function section

Press the [NEXT] button.

Repeatedly press the button until "[1]" — "[6]" are displayed above the [1] — [6] buttons.

Refer to 'Notes on Multi-function Key System' (page 10).

3 Call up the station

Press the desired [1] — [6] button.

Function of Remote

SNPP (Station Name Preset Play)

Displaying the program service name and selecting the station.

1 Enter SNPP mode

Press the [DNPP] button on the remote.

When "SNPP" is displayed, the program service name displays in the FM1, FM2, FM3 and AM band in order.



- For stations without a program service name the frequency is displayed instead.

Changing the display order

Press the [◀◀] or [▶▶] button.

Changing the displayed band

Press the [FM] or [AM] button.

2 If the station you want is displayed

Press the [OK] button on the remote.

The station for the program service name being displayed is received.

Canceling the SNPP mode

Press the [DNPP] button on the remote.

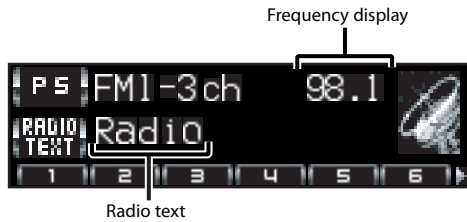
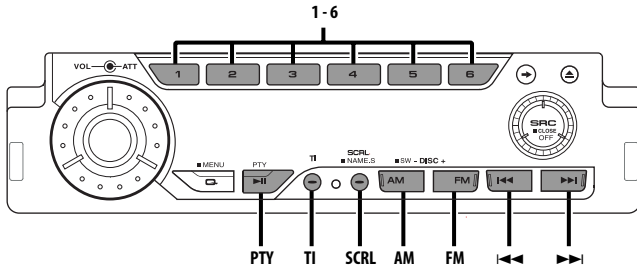

Traffic Information

Switching to traffic information automatically when a traffic bulletin starts even when you aren't listening to the radio.

Press the [TI] button.

Each time the button is pressed the Traffic Information function turns ON or OFF:

When it's ON, "Traffic Info"/ "Announcement" is displayed:

When a traffic bulletin starts, "Traffic Info"/ "Announcement" is displayed and it switches to traffic information.



- During reception of an AM station when the Traffic Information function is turned ON, it switches to an FM station.
- During reception of traffic information the adjusted volume is automatically remembered, and the next time it switches to traffic information it's automatically the remembered volume.

Radio Text Scroll

Scrolling the displayed radio text.

Press the [SCRL] button.

PTY (Program Type)

Selecting the Program Type and searching for a station.

1 Enter PTY mode

Press the [PTY] button.



- This function can't be used during a traffic bulletin or AM reception.

2 Select the Program Type

Press the [FM] or [AM] button.

Each time the button is pressed the Program Type switches as shown below.

No.	Program Type	Display
1.	Speech	"All Speech"
2.	Music	"All Music"
3.	News	"News"
4.	Current Affairs	"Current Affairs"
5.	Information	"Information"
6.	Sport	"Sport"
7.	Education	"Education"
8.	Drama	"Drama"
9.	Culture	"Cultures"
10.	Science	"Science"
11.	Varied	"Varied Speech"
12.	Pop Music	"Pop Music"
13.	Rock Music	"Rock Music"
14.	Easy Listening Music	"Easy Listening M"
15.	Light Classical	"Light Classic M"
16.	Serious Classical	"Serious Classics"
17.	Other Music	"Other Music"
18.	Weather	"Weather & Metr"
19.	Finance	"Finance"
20.	Children's programs	"Children's Prog"
21.	Social Affairs	"Social Affairs"
22.	Religion	"Religion"
23.	Phone In	"Phone In"
24.	Travel	"Travel & Touring"
25.	Leisure	"Leisure & Hobby"
26.	Jazz Music	"Jazz Music"
27.	Country Music	"Country Music"
28.	National Music	"National Music"
29.	Oldies Music	"Oldies Music"
30.	Folk Music	"Folk Music"
31.	Documentary	"Documentary"



- Speech and Music include the Program type shown below.
Music: No.12 — 17, 26 — 30
Speech: No.3 — 11, 18 — 25, 31
- The Program Type can be put in the [1] — [6] button memory and called up quickly. Refer to the 'Program Type preset' (page 36).
- The display language can be changed. Refer to 'Changing Language for PTY Function' (page 37).

3 Search for the selected Program Type station

Press the [◀◀] or [▶▶] button.

When you want to search for other stations press the [◀◀] or [▶▶] button again.



- When the selected Program Type isn't found, "NO PTY" is displayed. Select another Program Type.

4 Exit PTY mode

Press the [PTY] button.

Program Type preset

Putting the Program Type in the Preset button memory and calling it up quickly.

Presetting the Program Type

1 Select the Program Type to preset

Refer to 'PTY (Program Type)' (page 36).

2 Preset the Program Type

Press the desired [1] — [6] button for at least 2 seconds.

Calling up the preset Program Type

1 Enter PTY mode

Refer to 'PTY (Program Type)' (page 36).

2 Call up the Program Type

Press the desired [1] — [6] button.

Changing Language for PTY Function

Selecting the Program Type display language.

1 Enter PTY mode

Refer to 'PTY (Program Type)' (page 36).

2 Enter Changing Language mode Press the [SCRL] button.

3 Select the language

Press the [FM] or [AM] button.

Each time the button is pressed the language switches as shown below.

Language	Display
English	"English"
Spanish	"Spanish"
French	"French"
Dutch	"Dutch"
Norwegian	"Norwegian"
Portuguese	"Portuguese"
Swedish	"Swedish"
German	"German"

4 Exit Changing Language mode Press the [SCRL] button.

CD/MP3/WMA/External disc control features

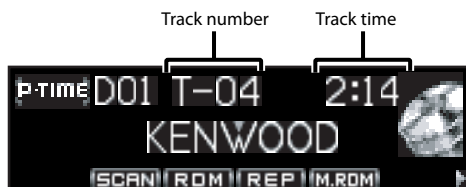
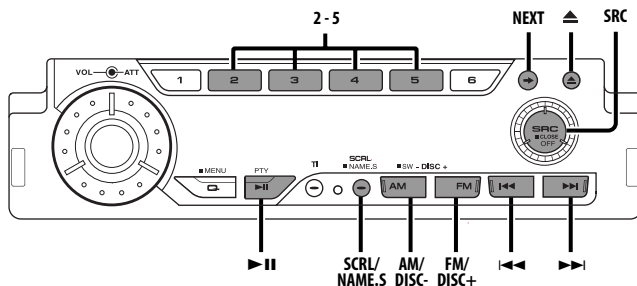

Playing CD & MP3/WMA

When there is no disc inserted

- 1 Open the panel to insert disc
Press the [▲] button.
- 2 Insert a disc.



- When the faceplate has been slid open, it might interfere with the shift lever or something else. If this happens, pay attention to safety and move the shift lever or take an appropriate action, then operate the unit.



- The sound will be temporarily muted while the faceplate is moving.

When a disc is inserted

- Press the [SRC] button.
Select the "Compact Disc" display.

Pause and play

Press the [▶||] button.

Each time the button is pressed the song pauses or plays.

Eject the disc

- 1 Eject the disc

Press the [▲] button.

- 2 Return the panel to the original position

Press the [▲] button.



- 3 in. (8cm) disc can't be played. Using an adapter and inserting them into this unit can cause damage.



- The MP3/WMA media that this unit can play are CD-ROM, CD-R, and CD-RW. The medium formats must be ISO 9660 Level 1, Level 2, Joliet, or Romeo. The methods and precautions to be followed for writing MP3/WMA data are covered in 'Notes on playing MP3/WMA' (page 8). Check that section before creating your MP3/WMA media.

Playing External Disc

Playing discs set in the optional accessory disc player connected to this unit.

Press the [SRC] button.

Select the display for the disc player you want.

Display examples:

Display	Disc player
"Compact Disc"	CD player
"CD Changer"	CD changer
"MD Changer"	MD changer

Pause and play

Press the [▶II] button.

Each time the button is pressed it pauses and plays.



- The functions that can be used and the information that can be displayed will differ depending on the external disc players being connected.

Fast Forwarding and Reversing

Fast Forwarding

Hold down on the [▶▶] button.

Release your finger to play the disc at that point.

Reversing

Hold down on the [◀◀] button.

Release your finger to play the disc at that point.

Track/File Search

Searching for a song on the disc or in the MP3/WMA folder.

Press the [◀◀] or [▶▶] button.

Function of disc changer/ MP3/ WMA

Disc Search/Folder Search

Selecting the disc set in the Disc changer or the folder recorded on the MP3/WMA media.

Press the [DISC-] or [DISC+] button.

Function of remote

Direct Track/File Search

Doing Track/File Search by entering the track/file number.

1 Enter the track/file number

Press the number buttons on the remote.

2 Do Track/File Search

Press the [◀◀] or [▶▶] button.

Canceling Direct Track/File Search

Press the [▶II] button.

Function of disc changers with remote

Direct Disc Search

Doing Disc Search by entering the disc number.

1 Enter the disc number

Press the number buttons on the remote.

2 Do Disc Search

Press the [DISC+] or [DISC-] button.

Canceling Direct Disc Search

Press the [▶II] button.

CD/MP3/WMA/External disc control features

Track/File/Disc/Folder Repeat

Replaying the song, disc in the Disc changer or MP3/WMA folder you're listening to.

1 Select the key function section

Press the [NEXT] button.

Repeatedly press the button until "REP" is displayed above the [4] button.

Refer to 'Notes on Multi-function Key System' (page 10).

2 Turn ON/OFF the Repeat Play

Press the [4] ("REP") button.

Each time the button is pressed the Repeat Play switches as shown below.

In CD & External disc source

Repeat play	Display
Track Repeat (In Disc Changer)	"Repeat ON" "Track Repeat ON"
Disc Repeat (In Disc Changer)	"Disc Repeat ON"
OFF	"Repeat OFF"

In MP3/WMA source

Repeat play	Display
File Repeat	"File Repeat ON"
Folder Repeat	"Folder Repeat ON"
OFF	"Repeat OFF"

Scan Play

Playing the first part of each song on the disc or MP3/WMA folder you are listening to and searching for the song you want to listen to.

1 Select the key function section

Press the [NEXT] button.

Repeat to press the button until "SCAN" is displayed above the [2] button.

Refer to 'Notes on Multi-function Key System' (page 10).

2 Start Scan Play

Press the [2] ("SCAN") button.

"Scan ON" is displayed.

3 Release it when the song you want to listen to is played

Press the [2] button.

Random Play

Play all the songs on the disc or MP3/WMA folder in random order.

1 Select the key function section

Press the [NEXT] button.

Repeatedly press the button until "RDM" is displayed above the [3] button.

Refer to 'Notes on Multi-function Key System' (page 10).

2 Turn ON/OFF the Random Play

Press the [3] ("RDM") button.

Each time the button is pressed Random Play turns ON or OFF.

When it's ON, "Random ON" is displayed.



- When the [▶▶] button is pressed, the next song select starts.

Function of disc changer

Magazine Random Play

Play the songs on all the discs in the disc changer in random order.

1 Select the key function section

Press the [NEXT] button.

Repeatedly press the button until "M.RDM" is displayed above the [5] button.

Refer to 'Notes on Multi-function Key System' (page 10).

2 Turning ON/OFF the Magazine Random Play

Press the [5] ("M.RDM") button.

Each time the button is pressed the Magazine Random Play turns ON or OFF.

When it's ON, "M.Random ON" is displayed.



- When the [▶▶] button is pressed, the next song select starts.

Folder Select

Quickly selecting the folder you want to listen to.

1 Select the key function section

Press the [NEXT] button.

Repeatedly press the button until "FSEL" is displayed above the [5] button.

Refer to 'Notes on Multi-function Key System' (page 10).

2 Enter Folder Select mode

Press the [5] ("FSEL") button.

"FOLDER SELECT" is displayed.

During Select mode the folder information is displayed as shown below.

Folder name display

Displays the current folder name.



Folder number display

Displays the number in the folder belonging to the currently selected folder.

3 Select the folder level

Press the [FM] or [AM] button.

With the [FM] button you move 1 level down and with the [AM] button 1 level up.

Selecting a folder in the same level

Press the [◀◀] or [▶▶] button.

With the [◀◀] button you move to the previous folder, and with the [▶▶] button to the next folder.

Returning to the top level

Press the [4] ("HOME") button.

Scrolling the folder name display

Press the [SCRL] button.

4 Decide the folder to play

Press the [2] ("OK") button.

The Folder Select mode releases, and the MP3/WMA in the folder being displayed is played.



- The methods for moving to other folders in the folder select mode are different from those in the folder search mode.
See 'Notes on playing MP3/WMA' (page 8) for details.

Canceling the Folder Select mode

Press the [3] ("EXIT") button.

Disc Naming (DNPS)

Attaching a title to a CD.

1 Play the disc you want to attach a name to



- A title can't be attached to MD or MP3/WMA media.
- Refer to the 'Text Display Switching' (page14/18) and select the "DNPS" display.

2 Enter name set mode

Press the [NAME.S] button for at least 2 seconds.

"NAME SET" is displayed.

3 Move the cursor to the enter character position

Press the [◀◀] or [▶▶] button.

4 Select the character type

Press the [2] — [4] button.

Each time the button is pressed the character type switches as shown below.

Character type	Button
Alphabet (Upper case/ Lower case)	[2] ("A • a")
Numbers and symbols	[3] ("1")
Special characters (Accent characters)	[4] ("CHAR")

5 Select the characters

Press the [FM] or [AM] button.



- Characters can be entered by using a remote with a number button.
Example: If "DANCE" is entered.

Character	Button	Times pressed
"D"	[3]	1
"A"	[2]	1
"N"	[6]	2
"C"	[2]	3
"E"	[3]	2

6 Repeat steps 3 through 5 and enter the name.

7 Exit name set mode

Press the [NAME.S] button.



- When operation stops for 10 seconds the name at that time is registered, and Name Set mode closes.
- Media that you can attach names to
 - Internal CD player: 30 discs.
 - External CD changer/ player: Varies according to the CD changer/ player. Refer to the CD changer/ player manual.
- The name of a CD can be changed by the same operation you used to name it.

Text/Title Scroll

Scrolling the displayed CD text or MD title.

Press the [SCRL] button.

Function of disc changers with remote

DNPP (Disc Name Preset Play)

Selecting the CD displayed in the DNPS of the CDs set in the Disc changer.

1 Enter DNPP mode

Press the [DNPP] button on the remote.

When "DNPP" is displayed the DNPS display in order.

Forward / Reverse display

Press the [DISC-] or [DISC+] button.

2 When the disc you want is displayed

Press the [OK] button on the remote.

The disc being displayed is played.

Canceling the DNPP mode

Press the [DNPP] button on the remote.

GSM Hands Free Unit control features

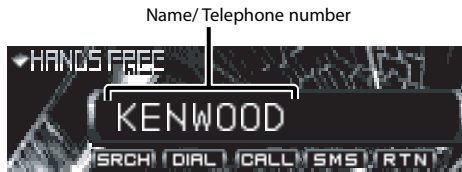
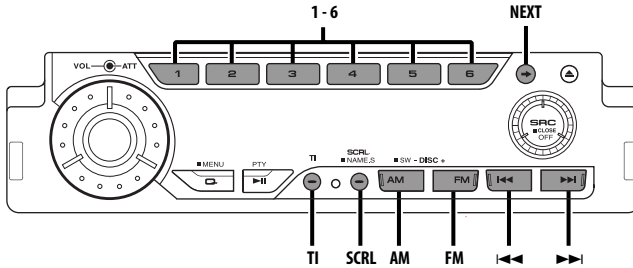

Receiving a call

Received calls can be answered when a GSM Hands Free Unit (optional accessory) is connected to this unit.

1 When a Call is Received

"Hands Free" will be displayed.

2 Accept a call

Press the [1], [3] — [6] or [NEXT] button.

Display: A

Switching between the Name and Telephone Number

Press the [TI] button.

Each time the button is pressed the display switches as shown below.

Information

Name

Telephone Number

3 Hang up

Press the [2] ("HANG") button.



- Inserting a disc while a call is in progress will cause the telephone to be hung up.

GSM Hands Free Unit control features

Phone Book Search

Selecting a telephone number from the phone book.

1 Select the key function section

Press the [NEXT] button.

Repeatedly press the button until "H-F" is displayed above the [2] (KDC-W8027)/ [3] (KDC-PSW9527/W9027) button.

Refer to 'Notes on Multi-function Key System' (page 10).

2 Enter Hands Free mode

Press the [2]/ [3] ("H-F") button.

3 Select the Phone Book Search Mode item

Press the [2] ("SRCH") button.

Each time the button is pressed the mode switches as follows:

Phone Book Search Mode item	Display
Initial Select Mode	"Initial SEL"
Redial Mode	"Redial"

4 Select the initial of a person to dial (In Initial Select Mode)

Press the [FM] or [AM] button.



- Initials including no corresponding name will not be displayed.

5 Switch the Name

Press the [◀◀] or [▶▶] button.

Switching between the Name and Telephone Number

Press the [TI] button.



- Not available if the name has not been stored.
- Not applicable if the text scroll function has been set to Auto (in menu).

Scrolling the Name and Telephone Number

Press the [SCRL] button.

6 Dial a selected number

Press the [4] ("CALL") button.

7 Hang up

Press the [2] ("HANG") button.

Canceling the Hands Free mode

Press the [6] ("RTN") button.

Function of remote

Direct Dial

Inputting the telephone number with number buttons on the remote, and dialing.

1 Select the key function section

Press the [NEXT] button.

Repeatedly press the button until "H-F" is displayed above the [2]/ [3] button.

Refer to 'Notes on Multi-function Key System' (page 10).

2 Enter Hands Free mode

Press the [2]/ [3] ("H-F") button.

3 Select the Dial Mode

Press the [3] ("DIAL") button.

"Number Dial" is displayed.

4 Enter the telephone number

Press the number [#], [*] and [+] (ANG) buttons on the remote.



- You can input max 32 digits.
- If an incorrect digit is entered, pressing the [◀◀] button will clear it.

5 Dial an input number

Press the [4] ("CALL") button.

6 Hang up

Press the [2] ("HANG") button.

Canceling the Hands Free mode

Press the [6] ("RTN") button.

SMS (Short Message Service) Mode

1 Select the key function section

Press the [NEXT] button.

Repeatedly press the button until "H-F" is displayed above the [2]/ [3] button.

Refer to 'Notes on Multi-function Key System' (page 10).

2 Enter Hands Free mode

Press the [2]/ [3] ("H-F") button.

3 Select the SMS Mode

Press the [5] ("SMS") button.

"SMS Mode" is displayed.

4 Select the Message

Press the [FM] or [AM] button.

5 Switch the Display

Press the [◀◀] or [▶▶] button.

Each time the button is pressed the mode switches as follows:

SMS Mode item
Name/ Phone Number
Date
Message

When the display line of a message is 'Text Scroll' (page 52) set to "Manual", scrolling is possible with [◀◀]/[▶▶], and when the setting is set to "Auto", scrolling is automatic.

Switching between the Name and Telephone Number

Press the [TI] button.

Scrolling the Name and Telephone Number display

Press the [SCRL] button.

6 Exit Hands Free mode

Press the [6] ("RTN") button.



- When New Message is Received, "New Message" is displayed.

Phone Book/ Message (SMS) data synchronize

Synchronizing the data in this unit with the data in the GSM telephone.

1 Select the key function section

Press the [NEXT] button.

Repeatedly press the button until "SYNC" is displayed above the [3] (KDC-W8027)/ [4] (KDC-PSW9527/W9027) button.

Refer to 'Notes on Multi-function Key System' (page 10).

2 Synchronize the data

Press the [3]/[4] ("SYNC") button.

The "GSM Memory SYNC" display turns off when data synchronization starts.

Menu system

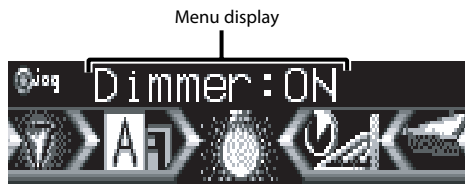
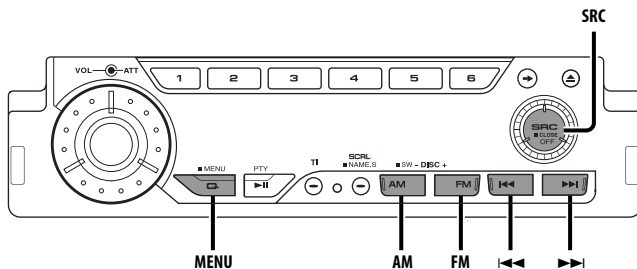

Menu System

Setting during operation beep sound etc. functions.

The Menu system basic operation method is explained here. The reference for the Menu items and their setting content is after this operation explanation.

1 Enter Menu mode

Press the [MENU] button for at least 1 second.

"MENU" is displayed.

2 Select the menu item

Press the [FM] or [AM] button.

Example: When you want to set the beep sound select the "Beep" display.

3 Set the menu item

Press the [◀◀] or [▶▶] button.

Example: When "Beep" is selected, each time the button is pressed it switches "Beep: ON" or "Beep: OFF". Select 1 of them as the setting.

You can continue by returning to step 2 and setting other items.

4 Exit Menu mode

Press the [MENU] button.



- When other items that are applicable to the basic operation method above are displayed afterwards their setting content chart is entered. (Normally the uppermost setting in the chart is the original setting.) Also, the explanation for items that aren't applicable ('Manual Clock Adjustment' etc.) are entered step by step.

In Standby mode

Security Code

Because authorization by the Security Code is required when it's removed from the vehicle, personalizing this unit is by using the Security Code is a help in preventing theft.



- When the Security Code function is activated it can't be released.
Note, your Security Code is the 4 digit number entered in your "Car Audio Passport" in this package.

1 Enter Standby

Press the [SRC] button.

Select the "STANDBY" display.

2 Enter Menu mode

Press the [MENU] button for at least 1 second.

When "MENU" is displayed, "Security" is displayed.

3 Enter Security Code mode

Press the [◀◀] or [▶▶] button for at least 1 second.

When "ENTER" is displayed, "CODE" is displayed.

4 Select the digits to enter

Press the [◀◀] or [▶▶] button.

5 Select the Security Code numbers

Press the [FM] or [AM] button.

6 Repeat steps 4 and 5, and complete the Security Code.

7 Confirm the Security Code

Press the [▶▶] button for at least 3 seconds.

When "RE-ENTER" is displayed, "CODE" is displayed.

8 Do the step 4 through 7 step operation, and reenter the security code.

"APPROVED" is displayed.

The Security Code function activates.



- If you enter a Code different from your Security Code, you have to start over from step 4.

Press the Reset button and when it's removed from the battery power source

1 Turn the power ON.

2 Do the step 4 through 7 step operation, and reenter the security code.

"APPROVED" is displayed.

The unit can be used.



- If an incorrect code is input, "WAITING" is displayed, and the input prohibited time shown below is generated.
After the input prohibited time lapses, "CODE" is displayed, and input can be done.

Number of times the incorrect code was input	Input prohibited time
1	—
2	5 minutes
3	1 hour
4	24 hours

Touch Sensor Tone

Setting the operation check sound (beep sound) ON/OFF.

Display	Setting
"Beep: ON"	Beep is heard.
"Beep: OFF"	Beep canceled.

Manual Clock Adjustment



- This adjustment can be done when the 'Synchronize Clock' (page 48) is set as OFF.

1 Select Clock Adjustment mode

Press the [FM] or [AM] button.

Select the "Clock Adjust" display.

2 Enter Clock Adjust mode

Press the [◀◀] or [▶▶] button for at least 1 second.

The clock display blinks.

3 Adjust the hours

Press the [FM] or [AM] button.

Adjust the minutes

Press the [◀◀] or [▶▶] button.

4 Exit Clock adjustment mode

Press the [MENU] button.

Menu system

When hands free unit connecting; In Standby mode

Phone voice speaker setting

Selecting the speaker to output the Phone voice.

Display	Setting
"SP SEL: ALL"	Phone voice sent to the front and rear speaker.
"SP SEL: F-Right"	Phone voice sent to the front right speaker.
"SP SEL: F-Left"	Phone voice sent to the front left speaker.

When hands free unit connecting

Microphone sensitivity adjust

Adjusting the volume of the Microphone.

Display and Setting
"HF MIC ADJ: 00"
⋮
"HF MIC ADJ: 15" (Original setting)
⋮
"HF MIC ADJ: 31"

When hands free unit connecting

Auto Response time Adjust

Setting the time from an incoming call to the automatic response.

Display and Setting
"Wait Time: OFF"
"Wait Time: 1s"
⋮
"Wait Time: 5s" (Original setting)
⋮
"Wait Time: 30s"



- If the time set in the GSM telephone is shorter than that set in the unit, the former will be used.

Date Adjustment

- 1 Select Date Adjust mode**
Press the [FM] or [AM] button.
Select the "Date Adjust" display.
- 2 Enter Date Adjust mode**
Press the [◀◀] or [▶▶] button for at least 1 second.
The date display blinks.
- 3 Selecting the item (day, month, or year) to adjust**
Press the [◀◀] or [▶▶] button.
The items that are blinking are items that can be adjusted.
- 4 Adjust each item**
Press the [FM] or [AM] button.
- 5 Repeat step 3 and 4 operation and adjust the date.**
- 6 Exit Date adjustment mode**
Press the [MENU] button.

Date Mode

Setting the date format.

- 1 Select Date Mode**
Press the [FM] or [AM] button.
Select the "Date Mode" display.
- 2 Select the date format**
Press the [◀◀] or [▶▶] button.

Synchronize Clock

Synchronizing the RDS station time data and this unit's clock.

Display	Setting
"SYNC: ON"	Synchronizes the time.
"SYNC: OFF"	Adjust the time manually.



- It takes 3 to 4 minutes to synchronize the clock.

DSI (Disabled System Indicator)

A red indicator will blink on the unit after the faceplate is removed, warning potential thieves.

Display	Setting
"DSI: ON"	LED flashes.
"DSI: OFF"	LED OFF.

Selectable Illumination

Selecting the button illumination color as green or red.

Display	Setting
"Button: Red"	The illumination color is red.
"Button: Green"	The illumination color is green.

Triangle indicator setting

Sets the blinking mode during triangle indicator system adjustment (such as audio control, audio setup, multi-key system setup).

Display	Setting
"TRIAGL Blink:ON"	The Triangle indicator blinks.
"TRIAGL Blink:OFF"	The Triangle indicator does not blink.

Font Type Select

Selecting the display font.

1 Select Font Type Select Mode

Press the [FM] or [AM] button.

Select the "Font Select" display.

2 Select the font

Press the [◀◀] or [▶▶] button.

Dimmer

Dimming this unit's display automatically when the vehicle light switch is turned ON.

Display	Setting
"Dimmer: ON"	The display dims.
"Dimmer: OFF"	The display doesn't dim.

OFF Wait Time Setting

Setting the time until the faceplate hide operation starts after the power is turned OFF. The faceplate can be removed only during the set time period.

Display and Setting
"Off Wait : 0sec"
:
"Off Wait : 3sec" (Original setting)
:
"Off Wait : 25sec"

In Standby mode

Eject angle setting

This function sets the opening and closing operation of a panel when a disc is inserted and when it is ejected.

Display	Setting
"Eject ANG: Slope"	Opens and closes the panel while maintaining the angle of the control panel to the set angle.
"Eject ANG: Level"	Opens and closes the panel after setting the angle of the control panel to the horizontal position.

Menu system

In Standby mode

Panel action setting

Sets the panel movement when the panel action (back/forward movement) is set to its most end position.

Display	Setting
"Panel Control:1"	No angle can be adjusted if the panel position has been set to its most end position. Also, if you have set the angle below the horizontal position, the angle is set to horizontal when you set the panel to its most end position.
"Panel Control:2"	The angle can be adjusted regardless of the panel position.

Function of the KDC-W8027

System Q Setting

Setting whether the display indicates the System Q factors (Bass center frequency, Bass Q factor, Bass extend, Middle center frequency, Middle Q factor, and Treble center frequency) in Audio control.

Display	Setting
"System Q: ON"	The System Q factors are displayed.
"System Q: OFF"	The System Q factors aren't displayed.

Function of the KDC-PSW9527/KDC-W9027

Audio Setup

Switches between the Easy mode and PRO mode (for detailed setup) during Audio setup.

Display	Setting
"Audio Setup:Easy"	Selects the quick Audio setup.
"Audio Setup:PRO"	Selects the detailed Audio setup.



- Refer to 'Audio Setup (Easy)' (page 28) and 'Audio Setup (PRO)' (page 30).
"Audio Setup:Easy" : [CABIN] [SP-SEL] [SP-LEV] [CALL]
"Audio Setup:PRO" : [X'over] [DTA] [EQ] [SP-LEV] [MEMORY] [CALL]

In Standby mode

Built-in Amp Mute Setting

Toggles ON or OFF the mute control on the built-in amplifier.

Turning ON this control enhances the preout quality.

Display	Setting
"AMP Mute: OFF"	The built-in amplifier activates.
"AMP Mute: ON"	The built-in amplifier deactivates.

B.M.S. (Bass Management System)

Adjust the bass boost level of the external amplifier using the main unit.

Display	Setting
"AMP Bass: Flat"	Bass boost level is flat.
"AMP Bass: +6"	Bass boost level is low (+6dB).
"AMP Bass: +12"	Bass boost level is mid (+12dB).
"AMP Bass: +18"	Bass boost level is high (+18dB).



- Refer to the catalog or instruction manual for power amplifiers that can be controlled from this unit.
- For amplifiers there are the model that can be set from Flat to +18 dB, and the model that can be set from Flat to +12 dB.

When an amplifier that can only be set to +12 is connected to the unit, "AMP Bass: +18" won't work correctly even if it's selected.

B.M.S. Frequency Offset

Setting the central frequency boosted by B.M.S.

Display	Setting
"AMP FRQ: Normal"	Boost with the normal central frequency.
"AMP FRQ: Low"	Drop the normal central frequency 20%.

In Tuner mode

News Bulletin with Timeout Setting

It switches automatically when a news bulletin starts even if the radio isn't being listened to. Also, the time interval when interrupt is prohibited can be set.

Display and Setting

"News: OFF"

"News: 00min"

⋮

"News: 90min"

When "News: 00min" — "News: 90min" is set, the News Bulletin Interrupt function is ON.

When it's ON, the "News " indicator is ON.

When the news bulletin starts, "News " is displayed, and it switches to the news bulletin.



- If you choose the "20min" setting, further news bulletins will not be received for 20 minutes once the first news bulletin is received.
- The news bulletin volume is the same level that was set for 'Traffic Information' (page 35).
- This function is only available if the desired station sends PTY-code for news bulletin or belongs to 'Enhanced Other Network'-Network sending PTY-code for news bulletin.
- When the News Bulletin Interrupt function is ON, it switches to an FM station.

In Tuner mode

Local Seek

Only stations whose reception is good are searched for in auto seek tuning.

Display Setting

"Local Seek: OFF" The local seek function is OFF.

"Local Seek: ON" The local seek function is ON.

In Tuner mode

Tuning Mode

Sets the tuning mode.

Tuning mode	Display	Operation
Auto seek	"Seek mode: Auto 1"	Automatic search for a station.
Preset station seek	"Seek mode: Auto 2"	Search in order of the stations in the Preset memory.
Manual	"Seek mode: Manual"	Normal manual tuning control.

In Tuner mode

Auto Memory Entry

For the operation method refer to 'Auto Memory Entry' (page 34).

AF (Alternative Frequency)

When poor reception is experienced, automatically switch to another frequency broadcasting the same program in the same RDS network with better reception.

Display Setting

"AF: ON" The AF function is ON.

"AF: OFF" The AF function is OFF.



- When no other stations with stronger reception are available for the same program in the RDS network, you may hear the incoming broadcast in bits and snatches. Turn OFF the AF function in such a case.

Restricting RDS Region (Region Restrict Function)

You can choose whether or not to restrict the RDS channels, received with the AF function for a particular network, to a specific region.

Display Setting

"Regional: ON" The Region Restrict Function is ON.

"Regional: OFF" The Region Restrict Function is OFF.



- Sometimes stations in the same network broadcast different programs or use different program service names.

Menu system

Auto TP Seek

When the TI function is ON and poor reception conditions are experienced when listening to a traffic information station, another traffic information station with better reception will be searched for automatically.

Display	Setting
"ATPS: ON"	The Auto TP Seek Function is ON.
"ATPS: OFF"	The Auto TP Seek Function is OFF.

In FM reception

Monaural Reception

Noise can be reduced when stereo broadcasts are received as monaural.

Display	Setting
"MONO: OFF"	The monaural reception is OFF.
"MONO: ON"	The monaural reception is ON.

Text Scroll

Setting the displayed text scroll.

Display	Setting
"Scroll: Manual"	Doesn't scroll.
"Scroll: Auto"	Scrolls when the display changes.



- The text scrolled is shown below.
 - CD text
 - Folder name/ File name/ Song title/ Artist name/ Album name
 - MD title
 - Radio text
 - Text for GSM hands free source (message, etc.)

Power OFF Timer

Setting the timer to turn this unit's power OFF automatically when Standby mode continues. Using this setting can save the vehicle's battery power.

Display	Setting
"OFF: - - - - -"	Power OFF Timer function is OFF.
"OFF: 20min" (Original setting)	Turns the power OFF after 20 minutes.
"OFF: 40min"	Turns the power OFF after 40 minutes.
"OFF: 60min"	Turns the power OFF after 60 minutes.



- This setting is done after setting 'Security Code' (page 46).

Built-in Auxiliary input Setting

Set the Built-in Auxiliary Input function.

Display	Setting
"Builtin AUX: OFF"	When selecting the source there's no Auxiliary Input.
"Builtin AUX: ON"	When selecting the source there's Auxiliary Input.

In Standby mode

CD Read Setting

When there is a problem on playing a CD with special format, this setting play the CD by force.

Display	Setting
"CD READ: 1"	Play CD and MP3/WMA.
"CD READ: 2"	Play CD by force.



- Setting "CD READ: 2" cannot play MP3/WMA. Some music CDs may not be played back even in the "CD READ: 2" mode.

Function of the KDC-PSW9527

In Standby mode

Picture downloading

Downloading movies and wallpapers. Downloaded pictures can be used for the display of this unit.

1 Inset a CD-R/CD-RW.

Insert a CD-R/CD-RW containing files to be downloaded into this unit.
Refer to 'Playing CD & MP3/WMA' (page 38) for details.
Our URL <http://www.kenwood.net-disp.com> describes how to make CD-R/CD-RW.

2 Enter Standby

Press the [SRC] button.

Select the "STANDBY" display.

3 Enter Menu mode

Press the [MENU] button for at least 1 second.

"MENU" is displayed.

4 Select the downloading mode

Press the [FM] or [AM] button.

Select the "DISP Data DL" display.

5 Enter the downloading mode

Press the [◀◀] or [▶▶] button.

"File Check!" is displayed.

6 Select files to be downloaded

Press the [FM] or [AM] button.

7 Start downloading

Press the [◀◀] or [▶▶] button for at least 2 seconds.

"Downloading" is displayed.

When the downloading finishes, "Finished Download" is displayed.



- Picture download may take as long as 10 minutes.



Gradation Level

Canceling Downloading

Press the [MENU] button.

8 Exit the downloading mode

Press the [MENU] button.



- The number of files that can be downloaded.
 - Downloaded movie: 1 file
 - Wallpaper: 1 file

- When a new movie is downloaded, it is overwritten to the currently downloaded movie.
Also, when a new wallpaper is downloaded, it is overwritten to the currently downloaded wallpaper.
There is no way to delete the downloaded pictures.
- The downloaded pictures can be used for display.
'Graphic part/ Spectrum Analyzer Display Switching' (page 17)
'Wallpaper selecting' (page 17)
- When you can't download the pictures to this unit, there may be a problem with the CD-R/CD-RW write method.
Refer to the URL <http://www.kenwood.net-disp.com>, and rewrite the CD-R/CD-RW.

When LX AMP unit connecting

AMP Control

You can control the LX AMP connected to the unit.

1 Select AMP Control mode

Press the [FM] or [AM] button.

Select the "AMP Control" display.

2 Enter AMP Control mode

Press the [◀◀] or [▶▶] button for at least 1 second.

3 Select the AMP Control item for adjustment

Press the [FM] or [AM] button.



- For the details of the AMP Control item, see the Instruction manual attached to the LX AMP.

4 Adjust the AMP Control item

Press the [◀◀] or [▶▶] button.

5 Exit AMP Control mode

Press the [MENU] button.



- You cannot use the LX AMP operation during standby mode.

Rotary volume operation select

Various items can be set using the rotary volume knob.

Display	Setting
"Rotary SEL:ON"	The rotary volume knob can be used for item setup.
"Rotary SEL:OFF"	The rotary volume knob cannot be used for item setup.



- To use the rotary volume knob for item setup, select "Rotary SEL: ON" and press the [1] button in each setup mode.

Basic Operations of remote

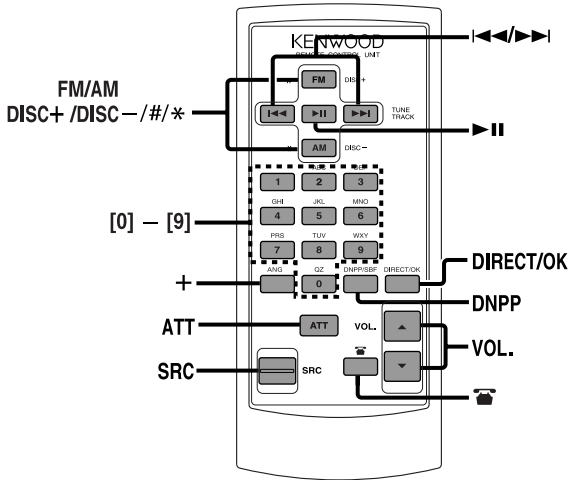

Loading and Replacing the battery

Use one lithium battery (CR2025).

Insert the batteries with the + and - poles aligned properly, following the illustration inside the case.

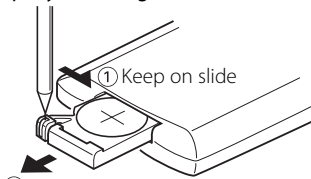

(2) Pull out

⚠ WARNING

- Store unused batteries out of the reach of children. Contact a doctor immediately if the battery is accidentally swallowed.



- Do not set the remote on hot places such as above the dashboard.

Basic operations

[VOL.] buttons

Adjusting the volume.

[SRC] button

Each time the button is pressed the source switches.

For the source switching order refer to 'Selecting the Source' (page 13).

[ATT] button

Turning the volume down quickly.

When it is pressed again it returns to the previous level.

Basic Operations of remote

In Tuner source

[FM]/ [AM] buttons

Select the band.

Each time the [FM] button is pressed it switches between the FM1, FM2, and FM3 bands.

[◀◀]/ [▶▶] buttons

Tune up or down band.

[0] — [9] buttons

Press buttons [1] — [6] to recall preset stations.

[DIRECT]/ [OK] button

Enters and cancels the 'Direct Access Tuning' (page 33) mode.

[▶II] button

Enters and cancels the 'PTY (Program Type)' (page 36) mode.

[DNPP] button

Enters and cancels the 'SNPP (Station Name Preset Play)' (page 34) mode.

In Disc source

[◀◀]/ [▶▶] buttons

Doing track/file forward and backward.

[DISC+]/ [DISC-] buttons

Doing disc/folder forward and backward.

[▶II] button

Each time the button is pressed the song pauses and plays.

[DNPP] button

Enters and cancels the 'DNPP (Disc Name Preset Play)' (page 42) mode.

[0] — [9] buttons

When in 'Direct Track/File Search' (page 39) and 'Direct Disc Search' (page 39), enter the track/file/disc number.

GSM Hands Free Unit operations

[◀◀]/ [▶▶] buttons

Switching the display.

[FM]/ [AM] buttons

Switching the initials and messages.

[0] — [9]/ [+]/ [#]/ [*] buttons

When in 'Direct Dial' (page 44), enter the telephone number.

[☎] button

Entering and switching the Hands Free mode.

Press the button for at least one second to dial a phone number or to hang up.

Accessories/ Installation Procedure

Accessories

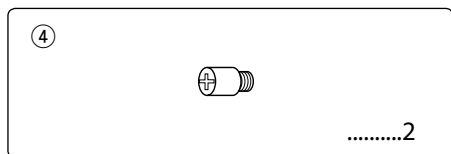
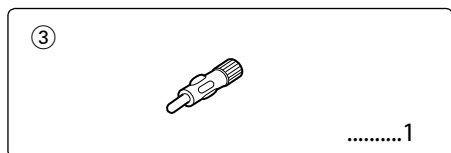
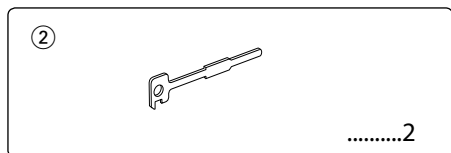
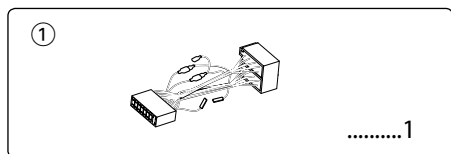

Installation Procedure

1. To prevent short circuits, remove the key from the ignition and disconnect the ⊖ terminal of the battery.
2. Make the proper input and output wire connections for each unit.
3. Connect the wire on the wiring harness.
4. Take Connector B on the wiring harness and connect it to the speaker connector in your vehicle.
5. Take Connector A on the wiring harness and connect it to the external power connector on your vehicle.
6. Connect the wiring harness connector to the unit.
7. Install the unit in your car.
8. Reconnect the ⊖ terminal of the battery.
9. Turn the vehicle's ignition key on and open the panel.
10. Press the [5] button and the reset button.



- If your car is not prepared for this special connection-system, consult your Kenwood dealer.
- Only use antenna conversion adapters (ISO-JASO) when the antenna cord has an ISO plug.
- Make sure that all wire connections are securely made by inserting jacks until they lock completely.
- If your vehicle's ignition does not have an ACC position, or if the ignition wire is connected to a power source with constant voltage such as a battery wire, the power will not be linked with the ignition (i.e., it will not turn on and off along with the ignition). If you want to link the unit's power with the ignition, connect the ignition wire to a power source that can be turned on and off with the ignition key.
- If the fuse blows, first make sure that the wires have not caused a short circuit, then replace the old fuse with one with the same rating.
- Insulate unconnected wires with vinyl tape or other similar material. To prevent short circuits, also do not remove the caps on the ends of the unconnected wires or the terminals.
- Connect the speaker wires correctly to the terminals to which they correspond. The unit may receive damage or fail to work if you share the ⊖ wires and/or ground them to any metal part in the car.
- After the unit is installed, check whether the brake lamps, indicators, wipers, etc. on the car are working properly.
- If the console has a lid, make sure to install the unit so that the faceplate does not hit the lid when closing and opening.
- Mount the unit so that the mounting angle is 30° or less.

Connecting Wires to Terminals

	A	B
KDC-PSW9527	Subwoofer output (Navy Blue)	Center output (Navy Blue)
KDC-W9027	Subwoofer output (Black)	—
KDC-W8027	Subwoofer right output (Red)	Subwoofer left output (White)

Antenna Conversion Adaptor (ISO-JASO) (Accessory③)

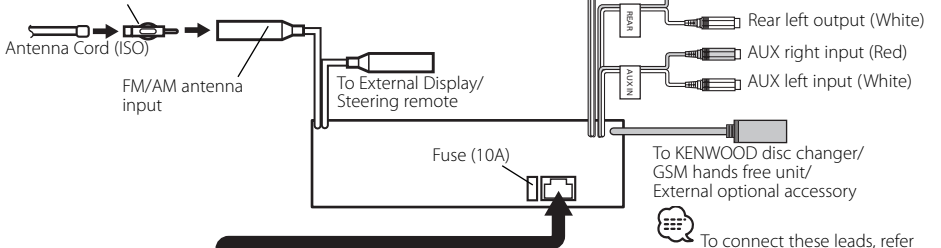

Wiring harness (Accessory①)

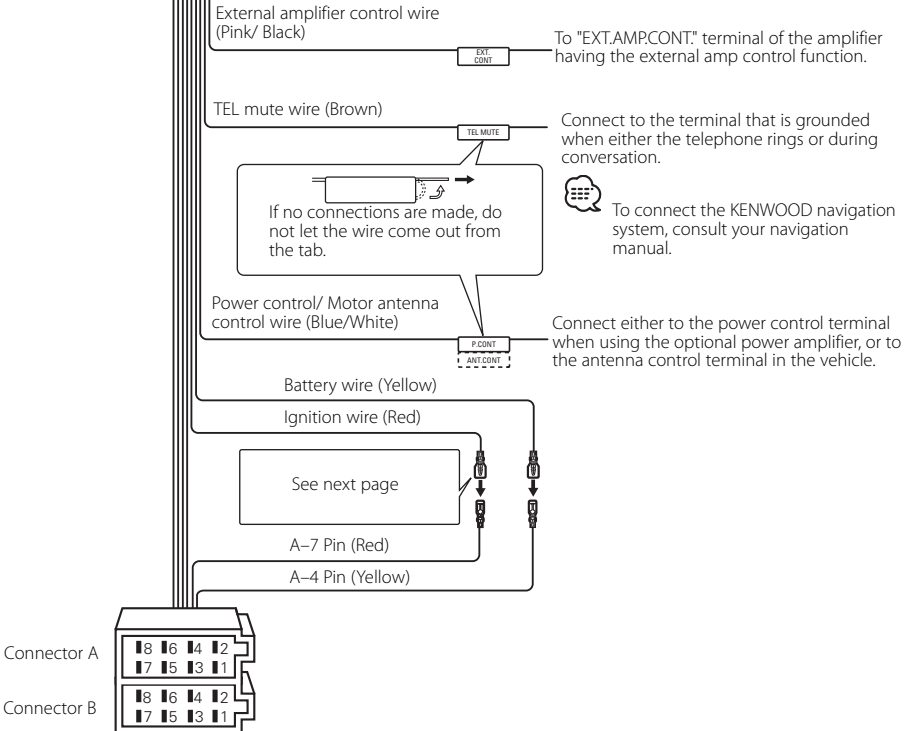

Connector Function Guide

Pin Numbers for ISO Connectors	Cable Colour	Functions
External Power Connector		
A-4	Yellow	Battery
A-5	Blue/White	Power Control
A-6	Orange/White	Dimmer
A-7	Red	Ignition (ACC)
A-8	Black	Earth (Ground) Connection
Speaker Connector		
B-1	Purple	Rear Right (+)
B-2	Purple/Black	Rear Right (-)
B-3	Gray	Front Right (+)
B-4	Gray/Black	Front Right (-)
B-5	White	Front Left (+)
B-6	White/Black	Front Left (-)
B-7	Green	Rear Left (+)
B-8	Green/Black	Rear Left (-)

⚠WARNING

Connecting the ISO Connector

The pin arrangement for the ISO connectors depends on the type of vehicle you drive. Make sure to make the proper connections to prevent damage to the unit. The default connection for the wiring harness is described in [1] below. If the ISO connector pins are set as described in [2] or [3], make the connection as illustrated. Please be sure to reconnect the cable as shown [2] below to install this unit to the **Volkswagen** vehicles etc.

- [1] (Default setting) The A-7 pin (red) of the vehicle's ISO connector is linked with the ignition, and the A-4 pin (yellow) is connected to the constant power supply.

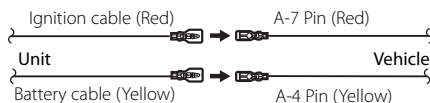

- [2] The A-7 pin (red) of the vehicle's ISO connector is connected to the constant power supply, and the A-4 pin (yellow) is linked to the ignition.

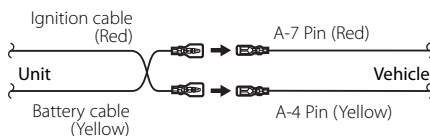

- [3] The A-4 pin (yellow) of the vehicle's ISO connector is not connected to anything, while the A-7 pin (red) is connected to the constant power supply (or both the A-7 (red) and A-4 (yellow) pins are connected to the constant power supply).

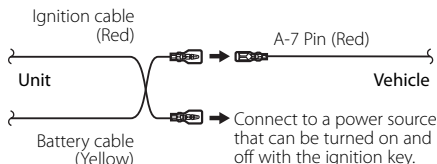

Installation

Metal mounting strap
(commercially available)

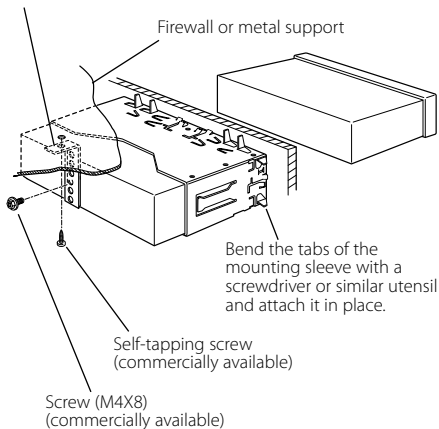

- Make sure that the unit is installed securely in place. If the unit is unstable, it may malfunction (for example, the sound may skip).

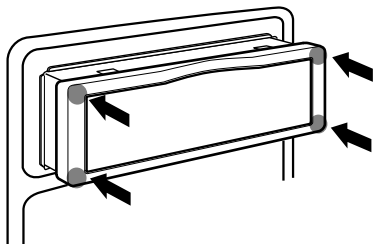

- To attach this unit, make sure the front of the control panel faces you and fit it into the mounting sleeve by pressing the four corners of the hard rubber frame at the same time.
Do not apply strong pressure to other sections than the corners; otherwise troubles such as the impossibility of opening or closing the panel may result.
- The hollow at the center of the rubber frame is designed to make it easier to remove discs.
If you do not want the hollow to be visible, mount the rubber frame in the opposite direction (with the flat side at the top instead of the bottom).

Locking the Backpanel to the unit

If you want to fasten the faceplate to the main unit so that it does not fall off.

- 1 Refer to the Removing the Backpanel function of the section on 'Theft Deterrent Panel' (page 20) and remove the Backpanel.
- 2 Insert the panel lock screws into the holes at the sides of the panel.

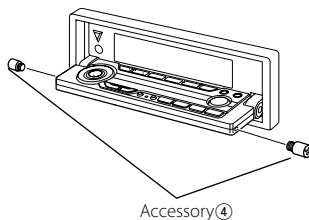

- 3 Reattach the Backpanel.



- Never insert the panel lock screws in any other screw holes than the one specified. If you insert them in another hole, it will contract and may cause damage to the mechanical parts inside the unit.

Removing the Unit

Removing the hard rubber frame

1 Engage the catch pins on the removal tool and remove the two locks on the upper level. Upper the frame and pull it forward as shown in the figure.

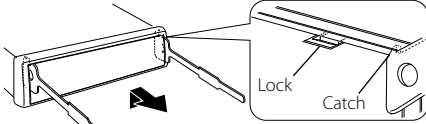

Accessory②
Removal tool

2 When the upper level is removed, remove the lower two locations.

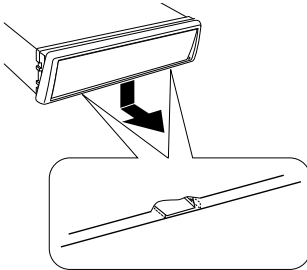

• The frame can be removed from the bottom side in the same manner.

Removing the Unit

1 Refer to the section 'Removing the hard rubber frame' (page 61) and then remove the hard rubber frame.

2 Remove the screw (M4 × 8) on the back panel.

3 Insert the two removal tools deeply into the slots on each side, as shown.

Screw (M4X8)
(commercially available)

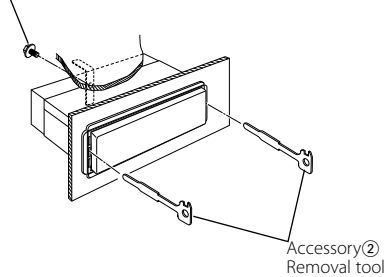

4 Lower the removal tool toward the bottom, and pull out the unit halfway while pressing towards the inside.

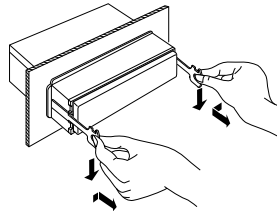

• Be careful to avoid injury from the catch pins on the removal tool.

5 Pull the unit all the way out with your hands, being careful not to drop it.

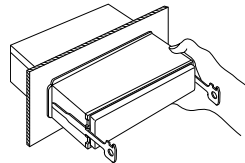

Troubleshooting Guide

What might seem to be a malfunction in your unit may just be the result of slight misoperation or miswiring. Before calling service, first check the following table for possible problems.

General

? The power does not turn ON.

- ✓ The fuse has blown.
 - ☞ After checking for short circuits in the wires, replace the fuse with one with the same rating.
- ✓ Speaker cable touches on chassis etc.
 - ☞ Wire or insulate the speaker cable properly and press the reset button.
- ✓ The Demonstration mode has been selected.
 - ☞ Hold down button [5] and press the Reset button to release the Demonstration mode.

? There's a source you can't switch.

- ✓ There's no media inserted.
 - ☞ Set the media you want to listen to. If there's no media in this unit, you can't switch to each source.
- ✓ The Disc changer isn't connected.
 - ☞ Connect the Disc changer. If the Disc changer isn't connected to its input terminal, You can't switch to an external disc source.

? The memory is erased when the ignition is turned OFF.

- ✓ The ignition and battery wire are incorrectly connected.
 - ☞ Connect the wire correctly, referring to the section on 'Connecting Wires to Terminals'.

? There's no loudness effect.

- ✓ The 'System Q' (KDC-W8027) (page 20) is set to SRS WOW.
 - ☞ Turn it to the other items.

? The TEL mute function does not work.

- ✓ The TEL mute wire is not connected properly.
 - ☞ Connect the wire correctly, referring to the section on 'Connecting Wires to Terminals'.

? The TEL mute function turns ON even though the TEL mute wire is not connected.

- ✓ The TEL mute wire is touching a metal part of the car.
 - ☞ Pull the TEL mute wire away from the metal part of the car.

? Even if Loudness is turned ON, high-pitched tone isn't compensated for.

- ✓ Tuner source is selected.
 - ☞ High-pitched tone isn't compensated for when in Tuner source.
- ✓ The 'System Q' (KDC-W8027) (page 20) is set to SRS WOW.
 - ☞ Turn it to the other items.

? The Bass center frequency, Bass quality factor, Bass extend, Middle center frequency, Middle quality factor, and Treble center frequency can't be adjusted.

- ✓ The 'System Q Setting' (page 50) is set OFF.
 - ☞ Set it ON.

? No sound can be heard, or the volume is low.

- ✓ The fader or balance settings are set all the way to one side.
 - ☞ Center the fader and balance settings.
- ✓ The input/output wires or wiring harness are connected incorrectly.
 - ☞ Reconnect the input/output wires or the wiring harness correctly. See the section on 'Connecting Wires to Terminals'.
- ✓ The values of Volume offset are low.
 - ☞ Turn up the Volume offset, referring to the section on 'Audio Control' (KDC-W8027) (page 22) / 'Audio control' (KDC-PSW9527/W9027) (page 26).
- ✓ The 'Built-in Amp Mute Setting' (page 50) is ON.
 - ☞ Turn it OFF.
- ✓ If the PLII is selected by 'Audio Setup (Easy mode)' (KDC-PSW9527/W9027) (page28) and if the Front speaker is set to "16 — 7*10" and the Center speaker is set to "16 over," the subwoofer does not sound.
 - ☞ ---

? The sound quality is poor or distorted.

- ✓ One of the speaker wires is being pinched by a screw in the car.
 - ☞ Check the speaker wiring.
- ✓ The speakers are not wired correctly.
 - ☞ Reconnect the speaker wires so that each output terminal is connected to a different speaker.

? Subwoofer Output, Subwoofer Low Pass Filter and Subwoofer setting can't be done.

- ✓ The 'Dual Zone System' (page 24) is ON.
 - ☞ Turn it OFF.

? The Touch Sensor Tone doesn't sound.

- ✓ The preout jack is being used.
 - ☞ The Touch Sensor Tone can't be output from the preout jack.

? Even though Synchronize Clock is ON, the clock can't be adjusted.

- ✓ The received RDS station isn't sending time data.
 - ☞ Receive another RDS station.

? The Dimmer function doesn't work.

- ✓ The Dimmer wire isn't connected correctly.
 - ☞ Check the Dimmer wire connection.

? The panel is not hidden even when the power is turned off.

- ✓ The protection function for preventing fingers or other things from getting caught in between the panel and this unit has been activated.
☞ Turn off the power again.

? Sound is interrupted when Dual Zone System is set to ON.

- ✓ When Dual Zone System is set to ON while the Menu system's 'AF (Alternative Frequency)' (page 51) is set to ON, the sound quality may be adversely affected if the internal source is set to the tuner.
☞ ---

? There are no audio control effects.

- ✓ FOCUS/ SRS 3D item on 'Audio control' (KDC-PSW9527/W9027) (page 26) and SRS WOW item on 'System Q' (KDC-W8027) (page 20) have no effect in rear output.
☞ ---

? The Control Panel moves although you do not desire.

- ✓ The Demonstration mode has been selected.
☞ Hold down button [5] and press the Reset button to release the Demonstration mode.

? Some speakers may not sound even if you control the "T-TONE".

- ✓ You have selected "None" by Speaker Select control.
☞ The speaker does not sound if it has been set to "None" by Speaker Select control.
- ✓ ---
☞ The subwoofer does not sound.

Tuner source

? Radio reception is poor.

- ✓ The car antenna is not extended.
☞ Pull the antenna out all the way.
- ✓ The antenna control wire is not connected.
☞ Connect the wire correctly, referring to the section on 'Connecting Wires to Terminals'.

? The desired frequency can't be entered with the Direct Access Tuning.

- ✓ A station that can't be received is being entered.
☞ Enter a station that can be received.
- ✓ You're trying to enter a frequency with a 0.01 MHz unit.
☞ What can be designated in the FM band is to 0.1 MHz.

? It isn't the set Traffic information sound volume.

- ✓ The set sound volume is less than the tuner sound volume.
☞ If the tuner sound volume is louder than the set sound volume, the tuner sound volume is used.

Disc source

? "AUX EXT" is displayed without achieving External disc control mode.

- ✓ Unsupported disc changer is connected.
☞ Use the disc changer mentioned in the 'About CD players/disc changers connected to this unit' (page 5) of the section on 'Safety precautions'.

? The specified disc does not play, but another one plays instead.

- ✓ The specified CD is quite dirty.
☞ Clean the CD.
- ✓ The disc is loaded in a different slot from that specified.
☞ Eject the disc magazine and check the number for the specified disc.
- ✓ The disc is severely scratched.
☞ Try another disc instead.

? A CD ejects as soon as it is loaded.

- ✓ The CD is quite dirty.
☞ Clean the CD, referring to the CD cleaning of the section on 'About CDs' (page 7).

? Can't remove disc.

- ✓ The cause is that more than 10 minutes has elapsed since the vehicle ACC switch was turned OFF.
☞ The disc can only be removed within 10 minutes of the ACC switch being turned OFF. If more than 10 minutes has elapsed, turn the ACC switch ON again and press the Eject button.

? The disc won't insert.

- ✓ There's already another disc inserted.
☞ Press the [▲] button and remove the disc.

? Direct Search can't be done.

- ✓ Another function is ON.
☞ Turn Random Play or other functions OFF.

? Track Search can't be done.

- ✓ For the discs/folders first or last song.
☞ For each disc/folder, Track Search can't be done in the backward direction for the first song or in the forward direction for the last song.

Troubleshooting Guide

MP3/WMA source

? Cannot play an MP3/WMA.

- ✓ The media is scratched or dirty.
 - ☞ Clean the media, referring to the CD cleaning of the section on 'About CDs' (page 7).

? The sound skips when an MP3/WMA is being played.

- ✓ The media is scratched or dirty.
 - ☞ Clean the media, referring to the CD cleaning of the section on 'About CDs' (page 7).
- ✓ The recording condition is bad.
 - ☞ Record the media again or use another media.

? The MP3/WMA track time isn't displayed correctly.

- ✓ ---
 - ☞ There are times when it isn't displayed correctly according to the MP3/WMA recording conditions.

If the following situations, consult your nearest service center:

Even though the disc changer is connected, the Disc Changer source is not ON, with "AUX EXT" showing in the display during the Changer Mode.

The messages shown below display your systems condition.

- Eject: No disc magazine has been loaded in the changer. The disc magazine is not completely loaded.
☞ Load the disc magazine properly.
No CD in the unit.
☞ Insert the CD.
- No Disc: No disc has been loaded in the disc magazine.
☞ Load a disc into the disc magazine.
- TOC Error: No disc has been loaded in the disc magazine.
☞ Load a disc into the disc magazine. The CD is quite dirty. The CD is upside-down. The CD is scratched a lot.
☞ Clean the CD and load it correctly.
- E-05: The CD is upside-down.
☞ Load the CD correctly.
- Blank Disc: Nothing has been recorded on the MD.
- No Track Disc: No tracks are recorded on the MD, although it has a title.
- E-15: Media was played that doesn't have data recorded that the unit can play.
☞ Use media that has data recorded that the unit can play.
- No Music Data: Media was played that doesn't have data recorded that the unit can play.
☞ Use media that has data recorded that the unit can play.
Files for picture downloading only are recorded in CD-R/CD-RW.
- No Panel: The faceplate of the slave unit being connected to this unit has been removed.
☞ Replace it.
- E-77: The unit is malfunctioning for some reason.
☞ Press the reset button on the unit. If the "E-77" code does not disappear, consult your nearest service center.
- Mecha Error: Something is wrong with the disc magazine. Or the unit is malfunctioning for some reason.
☞ Check the disc magazine. And then press the reset button on the unit. If the "Mecha Error" code does not disappear, consult your nearest service center.

<p>Hold Error: The protective circuit in the unit activates when the temperature inside the automatic disc changer exceeds 60°C (140°F), stopping all operation.</p> <ul style="list-style-type: none"> ✦ Cool down the unit by opening the windows or turning on the air conditioner. As the temperature falls below 60°C (140°F), the disc will start playing again. <p>NO NAME:</p> <ul style="list-style-type: none"> • Attempted to display DNPS during the CD play having no disc names preset. • Attempted to display SNPS during the receiving session of the station having no station name preset. • Attempted to display the ID3 tag while the MP3/WMA having no ID3 tag is being played. <p>Waiting: Radio text data is being received.</p> <p>Load: Discs are being exchanged in the Disc changer.</p> <p>Reading: The unit is reading the data on the disc.</p> <p>NO ACCESS: After setting it in the Disc Changer, DNPP was done without having it been played at least 1 time.</p> <p>IN (Blink): The CD player section is not operating properly.</p> <ul style="list-style-type: none"> ✦ Reinsert the CD. If the CD cannot be ejected or the display continues to flash even when the CD has been properly reinserted, please switch off the power and consult your nearest service center. <p>Unsupported File:</p> <p>A MP3/WMA is played with a format that this unit can't support.</p> <ul style="list-style-type: none"> ✦ ---- <p>Protected File: A copy-protected file is played.</p> <ul style="list-style-type: none"> ✦ ---- <p>Can't Download/ Download Error:</p> <p>This unit does not work properly for some reason.</p> <ul style="list-style-type: none"> ✦ Press the reset button to download it again. If this error is still displayed, consult a local Kenwood dealer. 	<p>No Display File:</p> <p>No file that can be downloaded is contained in the CD-ROM.</p> <ul style="list-style-type: none"> ✦ Make sure that a files created with referring to <http://www.kenwood.net_disp.com> is contained in the CD-ROM. Do not delete the extension (.kbn) created when the file was created. <p>Incorrect File: The file selected to be downloaded has a format that this unit cannot read.</p> <ul style="list-style-type: none"> ✦ Recreate the file. <p>Writing Error: Writing failed while the file was downloaded.</p> <ul style="list-style-type: none"> ✦ Try the downloading again. <p>DEMO MODE: The Demonstration mode has been selected.</p> <ul style="list-style-type: none"> ✦ Hold down button [5] and press the Reset button to release the Demonstration mode.
--	--

Specifications

Specifications subject to change without notice.

FM tuner section

Frequency range (50 kHz space)
: 87.5 MHz – 108.0 MHz
Usable sensitivity (S/N = 26dB)
: 0.7 μ V /75 Ω
Quieting Sensitivity (S/N = 46dB)
: 1.6 μ V /75 Ω
Frequency response (\pm 3.0 dB)
: 30 Hz – 15 kHz
Signal to Noise ratio (MONO)
: 65 dB
Selectivity (DIN) (\pm 400 kHz)
: \geq 80 dB
Stereo separation (1 kHz)
: 35 dB

MW tuner section

Frequency range (9 kHz space)
: 531 kHz – 1611 kHz
Usable sensitivity (S/N = 20dB)
: 25 μ V

LW tuner section

Frequency range
: 153 kHz – 281 kHz
Usable sensitivity (S/N = 20dB)
: 45 μ V

CD player section

Laser diode
: GaAlAs
Digital filter (D/A)
: 8 Times Over Sampling
D/A Converter
: 1 Bit
Spindle speed (CD-DA) (MP3) (WMA)
: 1000 – 400 rpm (CLV 2times)
Wow & Flutter
: Below Measurable Limit
Frequency response (\pm 1 dB)
: 10 Hz – 20 kHz
Total harmonic distortion (1 kHz)
: 0.01 %
Signal to Noise ratio (1 kHz)
: 105 dB
Dynamic range
: 93 dB
Channel separation
: 95 dB
MP3 decode
: Compliant with MPEG-1/2 Audio Layer-3
WMA decode
: Compliant with Windows Media Audio

Audio section

Maximum output power
: 50 W x 4
Output power (DIN 45324, +B=14.4V)
: 30 W x 4
Tone action
(KDC-W8027)
Bass : 60 Hz – 150 Hz \pm 8 dB
Middle : 500 Hz – 2 kHz \pm 8 dB
Treble : 10 kHz – 17.5 kHz \pm 8 dB
(KDC-PSW9527/W9027)
Bass : 60 Hz – 400 Hz \pm 9 dB
Middle : 500 Hz – 3.15 kHz \pm 9 dB
Treble : 4 kHz – 16 kHz \pm 9 dB
Preout level / Load (during disc play)
: 5000 mV/10 k Ω (KDC-PSW9527/W9027)
: 2000 mV/10 k Ω (KDC-W8027)
Preout impedance (during disc play)
: \leq 80 Ω (KDC-PSW9527/W9027)
: \leq 600 Ω (KDC-W8027)

Auxiliary input

Frequency response (\pm 1 dB)
: 20 Hz – 20 kHz
Input Maximum Voltage
: 1200 mV
Input Impedance
: 100 k Ω

General

Operating voltage (11 – 16V allowable)
: 14.4 V
Current consumption
: 10 A
Installation Size (W x H x D)
: 182 x 53 x 163 mm (KDC-PSW9527/W9027)
: 182 x 53 x 162 mm (KDC-W8027)
Weight
: 2.1 kg (KDC-PSW9527/W9027)
: 1.9 kg (KDC-W8027)

KENWOOD